

CHIGO

Service manual

Room airconditioner

Split Wall-Mounting Type

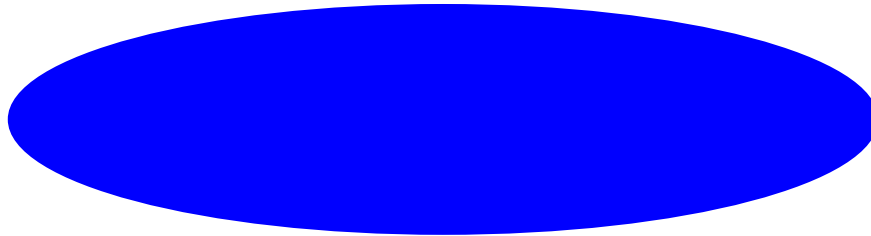

NOTE:

Before servicing the unit, please first read the service manual and then contact with your service center if meet problem

Table of the contents

A. Summary	page 3
B. Wiring diagram	page 4~5
C. Installation	page 6
D. Exploded view and part list	page 16
E. Components fault and test methods	page 22
F. Failure display	page 31
G. Troubleshooting	page 33
H. Usual failure analysis	page 39
I. User's manual	page 43~52

A. Summary

1. Indoor unit



2. Outdoor unit



3. Remote controller



Wiring diagram (OUTDOOR)

CS-25V3A-Y4U, CS-35V3A-H5S

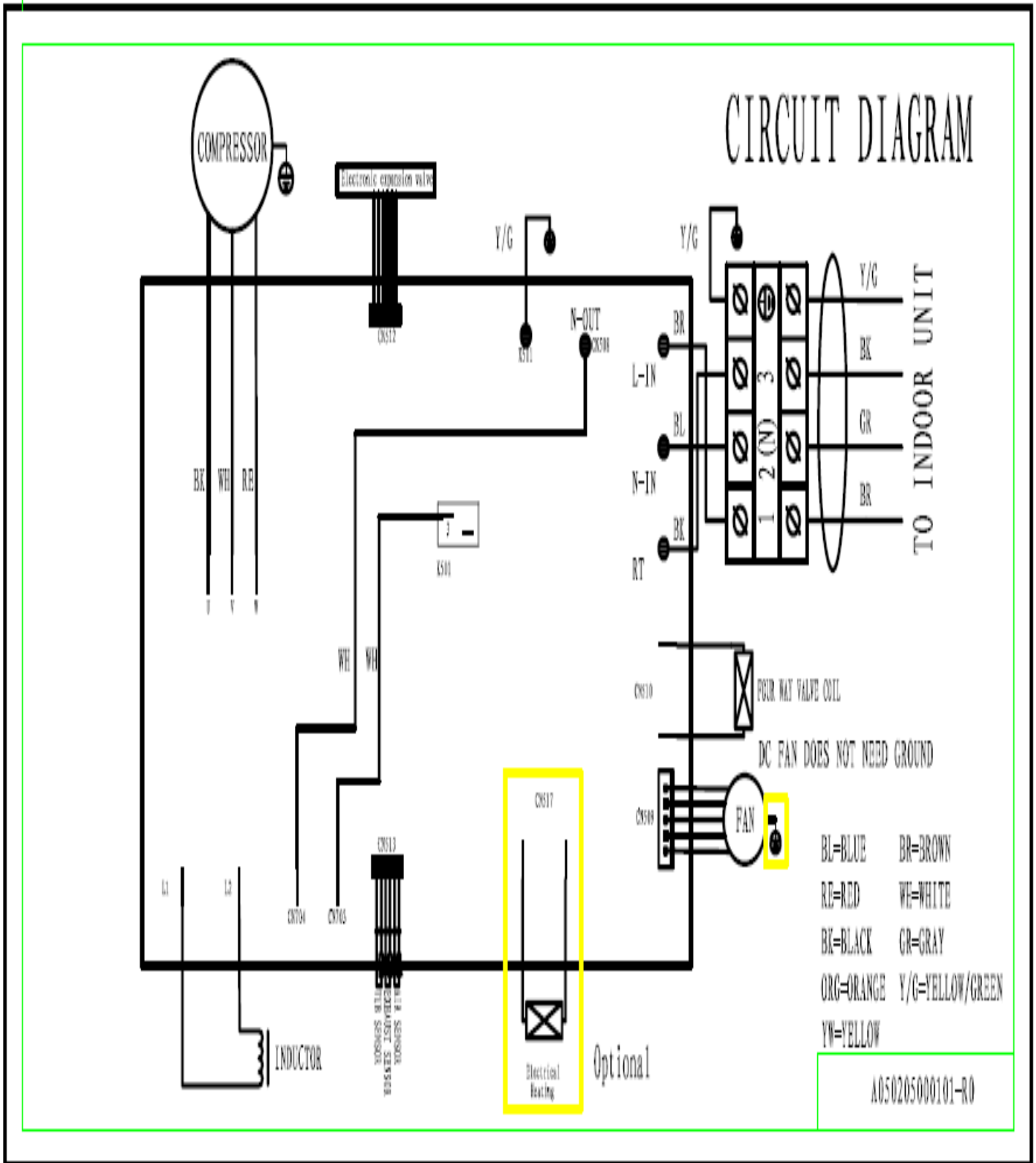

C. Installation

1. Safety Codes

- 1). The service supplier shall urge its service people to take effective human safety measures during operation.
- 2). The service people shall select an installation position that is solid, unlikely shocked and able to support the weight of machines.
- 3). To avoid fire, the installation position shall be away from the place where flammable gas exists.
- 4). When the outdoor unit is installed or relocated on the 2nd floor of a building or at a height over 2m, the service people must use the rope with adequate strength to fasten the outdoor unit securely (or take other safety measures) to prevent the machine from falling down.
- 5). For working on height, anti-fall measures shall be taken for the tools and materials used outside the building.
- 6). After completion, the installation people must carry out electrical safety inspection. The electrical wiring must be in conformance to the national or local safety standards to ensure no leakage.
- 7). If it is needed to refit the power supply during installation, approval must be obtained from the user and the operation must be carried out by the people qualified for electrical safety. The result must be in conformance to the national or local standards on electrical safety.
- 8). The service people must check each position of the casing during test run. In case of electric leakage, immediately stop the machine and check it. If it is the problem of installation, solve it and test again. Ensure the air conditioner works normally. If it is the problem of air conditioner, report it to the vendor.
- 9). During installation, if the service people find that the user's power supply has the potential safety problem, they must notify the user and record the details on the warranty card for confirmation, or take corrective actions.
- 10). Before completion of the installation or during removal or installation of the machine, it is prohibited to switch on the power and start the machine, in order to avoid safety accidents.
- 11). The service people must follow the national or local safety rules when using the welding tools. The welding must be performed by the people with safe operation qualification.
- 12). CHIGO has the right to supervise the service supplier for its work safety. The accidents due to the service supplier's fault shall be the service supplier's responsibility.
- 13). During installation, the service people shall take care to avoid skid, cutting, scratch, burn, electric shock or fall. Take care to protect the eyes during welding.
- 14). After installation, ensure that the people or objects are away from the machine before you connect the power supply. Do not switch on the power or test the machine until the power supply is correctly connected.

2. Preparation of installation tools

Table: Configuration of Installation Tools

Tool	1. Impact drill, with Ø70mm bit 1 pc	1	
	2. Bit, Ø10mm or Ø12mm 1 pc		
	3. Slotted screwdriver and cross screwdriver, 1 pc for each (mini slotted screwdriver)		Slotted: 100 or 120mm; Cross: 120 or 145mm
	4. Torque wrench (2 pcs), spanner (3 pcs)		Spanner: 8×10, 10×12, 12×14mm
	5. Hammer (1 pc)		0.5Kg
	6. Electrical knife (1 pc)		
	7. Wire stripper (1 pc)		

	8. Sharp nose pliers and cutting pliers (1 pc for each)	Cutting pliers: 150mm
	9. Pipe bender (1 set)	
	10. Pipe expander (1 set)	For the expanding the opening of the added pipe
	11. Pipe cutter (1 pc)	For cutting the excess copper tube)
	12. Reamer (1 pc)	For deburring the copper tube
	13. File (1 pc)	150 or 200mm
	14. Multimeter (1 set)	Level 5.0
	15. Leakage detector or soap / sponge (1 pc)	For detecting if there is leakage at the connection
	16. Thermometer or digital temperature meter (1 pc)	For measuring the temperature of the intake and outlet air of the air conditioner
	17. Pressure gauge	For measuring the working pressure of the air conditioner system
	18. Level gauge or plummet (1 pc)	
	19. Putty scraper (1 pc)	
	20. Hex wrench (1 set)	
	21. Electric probe	
	22. Safety belt	
	23. Rope (acc. to weight-bearing requirements)	
	24. Laying cloth, cover cloth, shoe covers, wiping cloth	
	25. Ladder and other requisite tools	

Other auxiliary materials (depending on the site conditions)

Materials	1. Fixing support for outdoor unit	GB/T5059GB/T5213
	2. Expansion bolt 10mm (4 pcs)	
	3. Anchoring bolt (Ø10mm) (with spring washer) (4 pcs)	
	4. Concrete nail	
	5. Heat insulation strap	
	6. Insulation tape	
	7. Gypsum powder (1 bag)	
	8. Copper tube and power cable	
	9. PVC pipe (optional)	
	10. Square channel (optional)	For fixing the connection pipes and wires
	11. Others	

3. Check the machine (whether the appearance is in good condition, and whether the accessories are complete)

Machine Inspection	<p>Focus on checking the single cooling, double temperature and cooling capacity whether conform to the specifications, in terms of the indoor and outdoor units are compatible, and the style of indoor unit conforms to the requirements.</p> <p>Look through the observation hole, and check whether the connection pipes, remote controller, Product Warranty Card and other accessories are complete. If not, do not open the package but contacting the vendor.</p>
--------------------	---

4. Check the user's power supply (kilowatt-meter capacity, wire diameter, electric leakage protection switch, ground wire and voltage)

Check the power supply	Use the multimeter to measure the power voltage, which shall be within +/-10% of the rated voltage.
	Use special line for the power supply of air conditioners, and ensuring that the capacity of entire supply line (branch line, power line, kilowatt-meter, air switch, etc) is higher than the maximum rated current of air conditioner.
	The power configuration and cable distribution must meet the local requirements for electrical safety.
	Advise the user to apply special air switch, electric leakage protector and other necessary protection devices for air conditioners. Their capacity shall meet the needs of air conditioner. For the line with fuse, it is prohibited to use copper wire to replace the fuse.

Table: The Requirements of Different Models for Power Supply

Table 1 (220V-240V)

Model	Item	Section Area of Power Cable (mm ²)	Circuit Switch (A)
Split Wall-Mounting Series			
25		1.0	10

5. Selection of Installation Position (Indoor / outdoor lens sequence needs adjustment)

Requirements for Installation Position	The installation shall be operated at the place which is solid, unlikely subject to shock and able to bear the weight of machine.
	The outdoor unit shall be installed at the place which with good ventilation, and unlikely subject to rain or direct sunshine. Ensuring that the air conditioner can be easily accessed for maintenance and repair.

	Keep the indoor and outdoor units as close as possible. The connection pipe shall be short as it might be.
	To facilitate the air flow, keep adequate space around the indoor and outdoor unit, and avoid flammable or corrosive gas nearby. The drainage shall not affect the constructions of dwellers underneath or the user himself.
	The machine shall be kept 2m or more away from the electric appliances and heat source.
	Avoid TV set, sound box, computer and other deluxe home appliances below the indoor unit.
	The indoor unit shall be able to blow the cold and hot air evenly to everywhere of the room.
	According to the power supply mode (powered by indoor or outdoor unit) and the length of power cable, select the position which close to the power supply, in order to facilitate the connection of power line. Moreover, ensuring that it is not needed to extend the power cable and selecting a position beyond reach of children.
Determination of Installation Position	Select the final position of indoor and outdoor unit according to the requirements above (Mark properly if needed).

6. Execution of Installation

Installation of Wall-mounted indoor unit	Unpack the machine and take out the accessories, wall-mounting plate and remote controller. Mount the bundled batteries into the remote controller and observe for abnormality. Before installation, make sure to energize the indoor unit and test it by using the remote controller. Observe the fan and swing louver for their working conditions. If any abnormality occurs, adjust immediately and install again.
--	--

Fix the wall-mounting plate according to the selected position of indoor unit and the route of the pipe.

Firstly, use a steel nail to fix the wall-mounting plate onto the wall. Level it with the level gauge and then fix tightly.

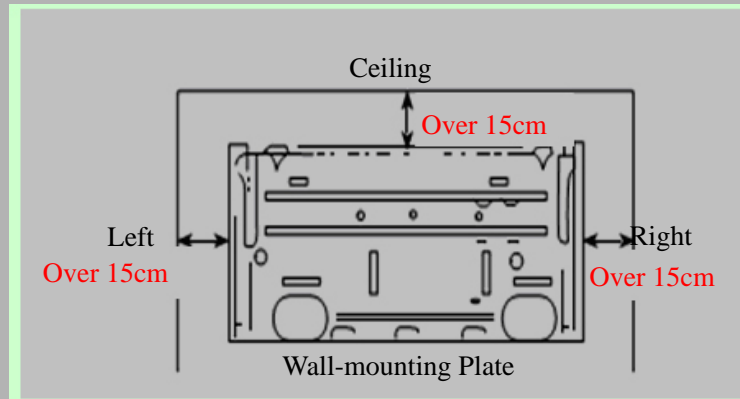

Note: When installing the models with additional functions (purification device), we shall take the position of this device into consideration for the distance to the ceiling.

Select the position of wall-cross hole according to the position of wall-mounting plate.

Selection of piping mode: Try not to choose the mode of right exit-pipe so as to ensure the orderliness and smoothness of the pipe.

1. Route the pipe directly along the right side of the machine body. 2. Route the pipe directly on the rear. When bending the pipe, please support the elbow with your right hand and then use your left hand to rotate slightly for 90° before stop. 3. Route the pipe along the left side. This step is the same as the above step. The only difference is that the bending angle is higher than that in the previous step, that is, it should be bent to 180°. Take care to rotate this angle slightly and slowly; Otherwise the pipe would be flattened easily. Then, drill a hole (should be a little larger than the outer diameter of the wall-cross tube so as to ensure the wall-cross tube can be inserted through). Caution: For easy drainage of the water out of the internal unit, the indoor unit shall be mounted slightly higher than the wall-cross hole. Meanwhile, the wall-cross hole must be inclined outward down.

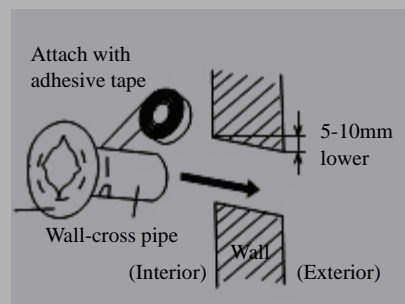

Make sure to take dustproof measures when drilling holes with the impact drill.

Hang the indoor unit onto the clamp of the wall-mounting plate. Move the body of indoor unit left and right, and check if it is fixed tight.

When multiple indoor units are to be installed in one room (e.g. guest hall, meeting room, restaurant, etc.), full consideration should be made to the integral appearance and working performance. They should be installed on the same level (with the upper as the benchmark) and keep a certain distance, thus to ensure that the working performance of each indoor unit will not be affected.

Installation of Outdoor Unit

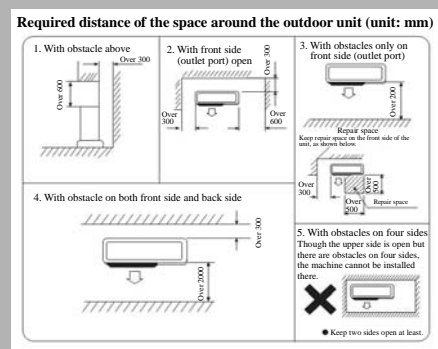

1. To install the outdoor unit onto the wall, use the bit of fixed depth to drill holes according to the selected position, but take care to avoid the wall clearance. Firstly, mount an expansion bolt 10x100 (mm). Then, use the rope to move the support outdoors and make a simple fixing. Calibrate the level with level gauge and mark out the other positioning holes. Then, remove the support and use the impact drill with fixed depth bit to drill the other fixing holes of the support. Finally, fix the support onto the exterior wall. 6 pcs required for model 61 or lower, and 8 pcs required for the model over 61.

Note: The expansion tube of the expansion screw must be fully punched into the wall.

1. Move the outdoor unit out of the room and put it onto the support with care. Fix with 4 bolts Ø10mm. (Note: The installation people working on the 2nd floor or higher must wear safety belt. The outdoor unit must be tied securely with rope before it can be put outdoors. Take anti-fall measures to avoid accident.)
 2. The outdoor unit is directly onto the ground (e.g. balcony, roof platform, outdoor ground of the 1st floor, and other platforms that can accommodate the outdoor unit adequately). According to the size of chassis mounting hole, select proper expansion screws to fix tightly. The height difference between indoor and outdoor unit shall not be higher than 5m; otherwise it might cause difficulty to oil return and affect the service performance.

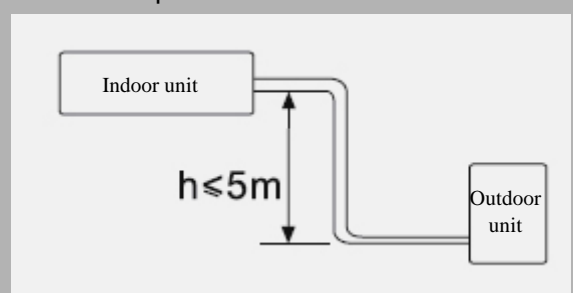

	<p>Installation Requirements for Multiple Units</p> <p>1. To install multiple units on the same wall or on the same direction of a building, all the machines on one floor should be installed on the same level (based on the level of machine leg), and the transverse spacing shall be kept at least 60cm or more, as long as the machine performance will not be affected.</p> <p>2. If there are multiple units on different floors on the same wall or the same direction of the building, they should be preferably installed on the same vertical line (based on the left side of the body streamline). To avoid air return or mutual interference at the outlet, the longitudinal spacing shall be kept at least 65cm or more.</p>
	<p>Requirements for outdoor guardrail (optional): If the user is to install guardrail for the outdoor unit, the spacing to the machine body must be kept 0.5m or more.</p>

Insert through Pipe	<p>Bundle the connection wire to the connection pipe and drainage pipe. (The connection wire may also be inserted through PVC pipe)</p>
	<p>To insert through the pipe, protective measures should be taken to prevent the expanded bell mouth from damage and prevent the sand from entering the connection pipe.</p>
Connect to Machine	<p>Take a connection pipe with expanded mouth, coat frozen oil evenly onto the connector of the 2-way / 3-way valve and the expanded mouth .</p>
	<p>Put the expanded mouth and connector on the same straight line and rotate the nut to its end with hands, and tighten it with spanner.</p>
	<p>Remove the end cover and clip of outdoor connection wire. Then, connect the wire to position according to color or mark indicated in the wiring diagram. When the exposed section is fully inserted, use the screw to press it tightly. Do not cut the round connector at the connection wire end into Y-shape. Fix the wire with clamp and then fix the end cover of the wire.</p>
Vacuuming	<p>After connecting the pipe between indoor and outdoor unit, it should be vacuumed with vacuum pump. Operate as follows: Loosen the nut on low-pressure valve element and filling portal, connect the vacuum pump to the filling portal by hose with pin, and then start the vacuum pump. When the indicator gauge points to 15Pa, stop vacuuming and hold for approx. 30s. Pay attention to the vacuum level. If decreased, be sure to eliminate the leakage. Repeat the above procedures. When the vacuuming process is completed, close the vacuum valve and open the high-pressure valve element for 1/4 turn to fill the refrigerant to the low-pressure section. Remove the connection hose. Fully open the high-pressure and low-pressure valves . Tighten the nuts on the valves.</p>

Leakage Detection	<p>Use a sponge soaked with soap water or a leakage detector to check the connectors and access-valves on indoor and outdoor units. Keep testing for no less than 3 minutes at each position. When the leakage detection is completed, do wash away the residual soap water. (Notes: In summer, leakage detection should be done under stop state. In winter, it should be done under heating mode).)</p> <p style="text-align: center;">Position Most Likely to Leak</p> <div style="display: flex; justify-content: space-around; align-items: center;"> <div style="text-align: center;"> <p>Nut for access door</p>  </div> <div style="text-align: center;"> <p>Nut for high/low pressure valve element</p> </div> </div> <p>Besides four connectors connecting outdoor pipes, nuts at high-pressure / low-pressure valve core and filling portal are most likely to leak but often neglected. Therefore, when installing the machine, make sure to fully open the valve core to dead position and tighten every nut and check for leakage.</p>
	The connector with leakage problem should be reinstalled.
	Pipe Wrapping and Wall Hole Blocking
	Sort the pipeline in good order.
	Use pipe bender when bend the pipe with 90°. To avoid flattening or cracking the pipe without pipe bender, do bend it with a radius as large as possible.

Table: Standard of piping torque:

1. Nut torque of connecting pipe (R410a、R407c)

Outer diameter of copper pipe		Torque
mm	inch	Kg.f/m
φ6.00	1/4	1.8
φ9.52	3/8	4.2
φ12.0	1/2	5.5
φ15.88	5/8	6.6
φ19.05	3/4	6.6

2. Nut torque of connecting pipe (R22)

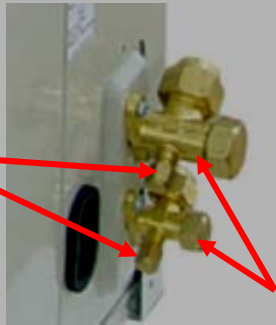
Outer diameter of steel pipe		Fastening torque		Reinforced fastening torque	
mm	inch	Kgf/m	Kgf/inch	Kgf/m	Kgf/inch
φ 6.00	1/4"	1.6	6.3	2.0	7.9
φ 9.52	3/8"	3.0	11.8	3.5	13.8

φ 12.0	1/2"	5.0	19.7	5.5	21.6
φ 15.88	5/8"	7.5	29.5	8.0	31.5
φ 19.05	3/4"	12.0	47.2	14	55.1

Pipeline wrapping and wall-hole blocking	<p>Wrap the connection pipe and machine-connection wires together, water pipe shall be placed under the connection pipe and shall not be wounded and intersected, and it shall be wrapped from outdoor unit to indoor unit in case rainwater entered and had bad influence on temperature and insulation.</p>
	<p>Heat insulation measures shall be adopted separately for the pipeline joint of the indoor unit.</p>
	<p>When the pipeline was wrapped, it shall be fixed on the wall by pipe clamps for every 1m distance.</p>
Inspection before machine testing	<p>Block the wall-hole with plaster or putty with the machine, in case the rainwater and the wind entered. Meanwhile, make the blockage match the wall as possible.</p>
	<p>Check if the internal wires of the unit are connected. It needs to be noted particularly that the wires shall be connected correspondingly; the grounding shall be reliable; and all the naked wires shall be pressed tightly. When the power was off, the insulating electric-resistance of the null line, the live wire and the ground wire of the plug shall be more than 2 megohm.</p>
	<p>Inspect whether the indoor and outdoor units are installed firmly.</p>
Power supply connection	<p>Make sure that all people or objectives are away from the machine, do check it's safe before turn the power on.</p>
	<p>Before installation and safety inspection, electrification is strictly forbidden.</p>
Inspection for machine test	<p>Power connection shall be in accordance to the region or country's safety requirements, and make sure that wires were firmly connected.</p>
	<p>When the power is on, turn on the machine by remote controller, and press every button to see if the machine responds. If the machine is a floor standing one, testing it with control panel is required.</p>
	<p>Inspect noise and vibration of the machine, if there are any abnormal phenomena, they shall be debugged or maintained.</p>
	<p>Inspect the drainage of the indoor unit. Pour a cup of water on the indoor unit evaporator and check the draining situation.</p>

	Use remote controller (control panel when floor standing machine) to adjust the indoor fan to carry out switching of high, medium and low air speed, inspect whether the air swinging is flexible.
	Record the data of working voltage, current, system pressure, temperature, differences of inlet and outlet air etc. under modes of cooling and heating. In case of abnormal conditions such as smell, scorched flavor, smoking and so on, do stop the machine for inspection and solving it immediately. If problems caused by anything from the user, advices shall be given to improve.

7. Introduction of usage and maintenance knowledge

Test of testing machine	After start, setting cooling or heating mode according to the temperature.
	The installation personnel shall introduce the usage of the remote controller in detail to the user, including the function of every button, and how to judge the battery shall be changed and how to change. The power shall be cut and the battery of remote controller shall be taken out when the machine is not used for a long time.
	Introduce the method of disassembling and cleaning the filter net (replacing the air filter) to the user, and instruct them to operate until they are skillful. The outdoor unit shall be ventilated, so as to prevent sundries from blocking the condenser and influencing the heat dissipation. Users can inspect and clean the condenser and remove sundries when they can guarantee their safety, or they shall ask professionals for help.

8. Ending (clear the site, collect tools, fill the warranty card and say goodbye to the user)

End of work	Hand over the instruction manual and accessories to the user.
	Collect the installation tools and do not ignore anything.
	Clean installation site, return the displaced articles and electric appliances.

D. Exploded view and part list

1. Indoor: CS-25V3A-M**A、CS-35V3A-M**A

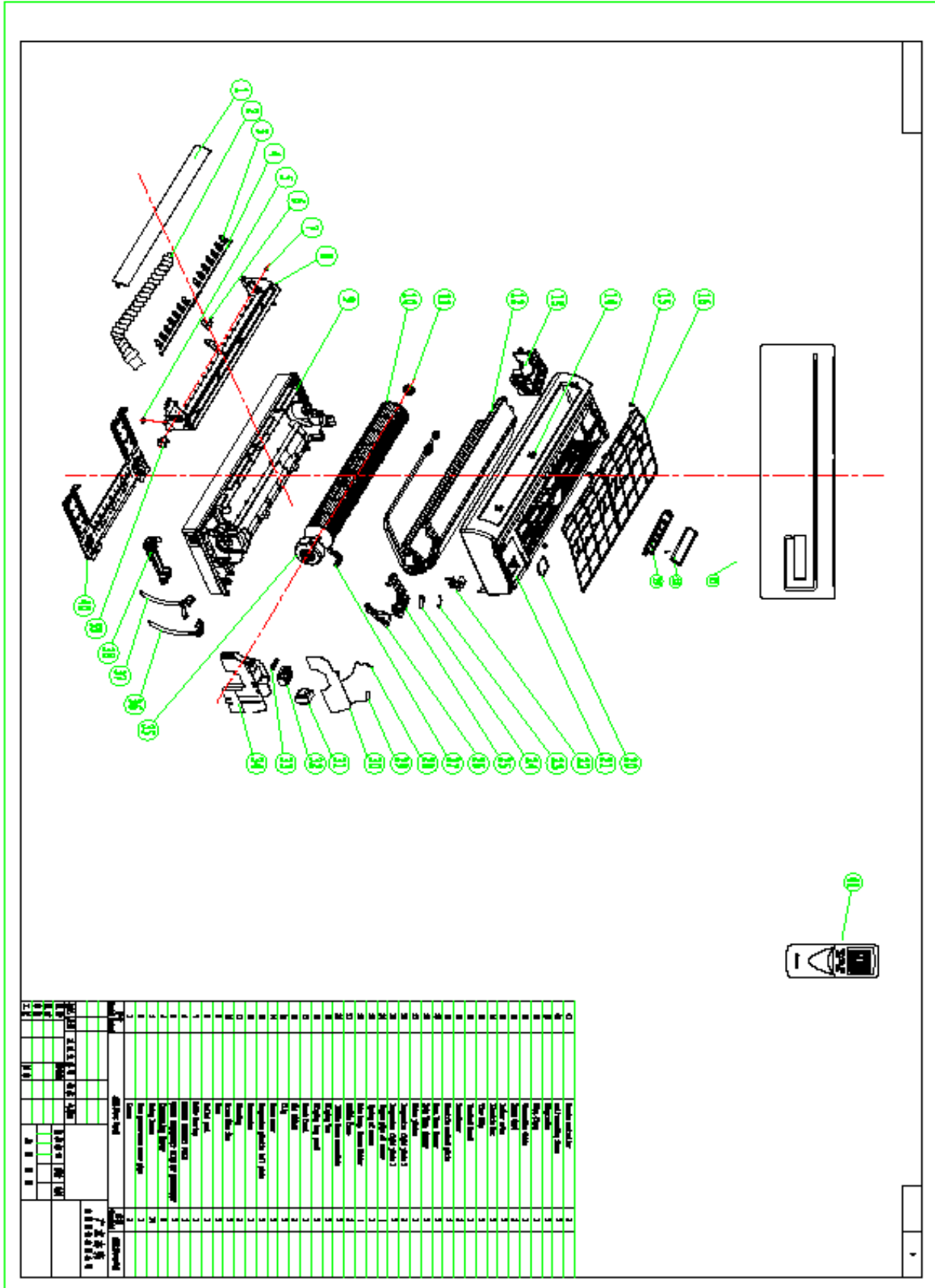

1 LOUVER

2	THERMAL INSULATION PIPE
3	SWING LOUVER
4	CONNECTING LEVER
5	WATER RESISTANT RING OF WATERPOUT
6	LOUVER SUPPORT POLE
7	GUIDE BEARING
8	OUTLET PART
9	BASE
10	CROSS FLOW FAN
11	BEARING
12	EVAPORATOR
13	EVAPORATOR PLASTIC LEFT PLATE
14	SCREW COVER
15	CLIP
16	AIR FILTER
17	FRONT PANEL
18	Display lamp panel
19	DISPLAY BOX
20	MIDDLE FRAME COVERPLATE
21	MIDDLE FRAME
22	TUBE TEMP. SENSOR HOLDER
23	SPRING OF SENSOR
24	COPPER PIPE OF SENSOR
25	EVAPORATOR RIGHT PLATE 1
26	EVAPORATOR RIGHT PLATE 2
27	MOTOR PLATEN
28	TUBE TEMP. SENSOR
29	ROOM TEMP. SENSOR
30	ELECTRIC CONTROL PLATE
31	TRANSFORMER
32	TERMINAL BOARD
33	WIRE CLIP
34	ELECTRIC BOX
35	INDOOR MOTOR
36	POWER CORD
37	CONNECTING CABLE
38	PIPE CLAMP
39	STEP MOTOR
40	WALL-MOUNTING FRAME
41	REMOTE CONTROLLER

2. Outdoor:

CS-25V3A-Y4U

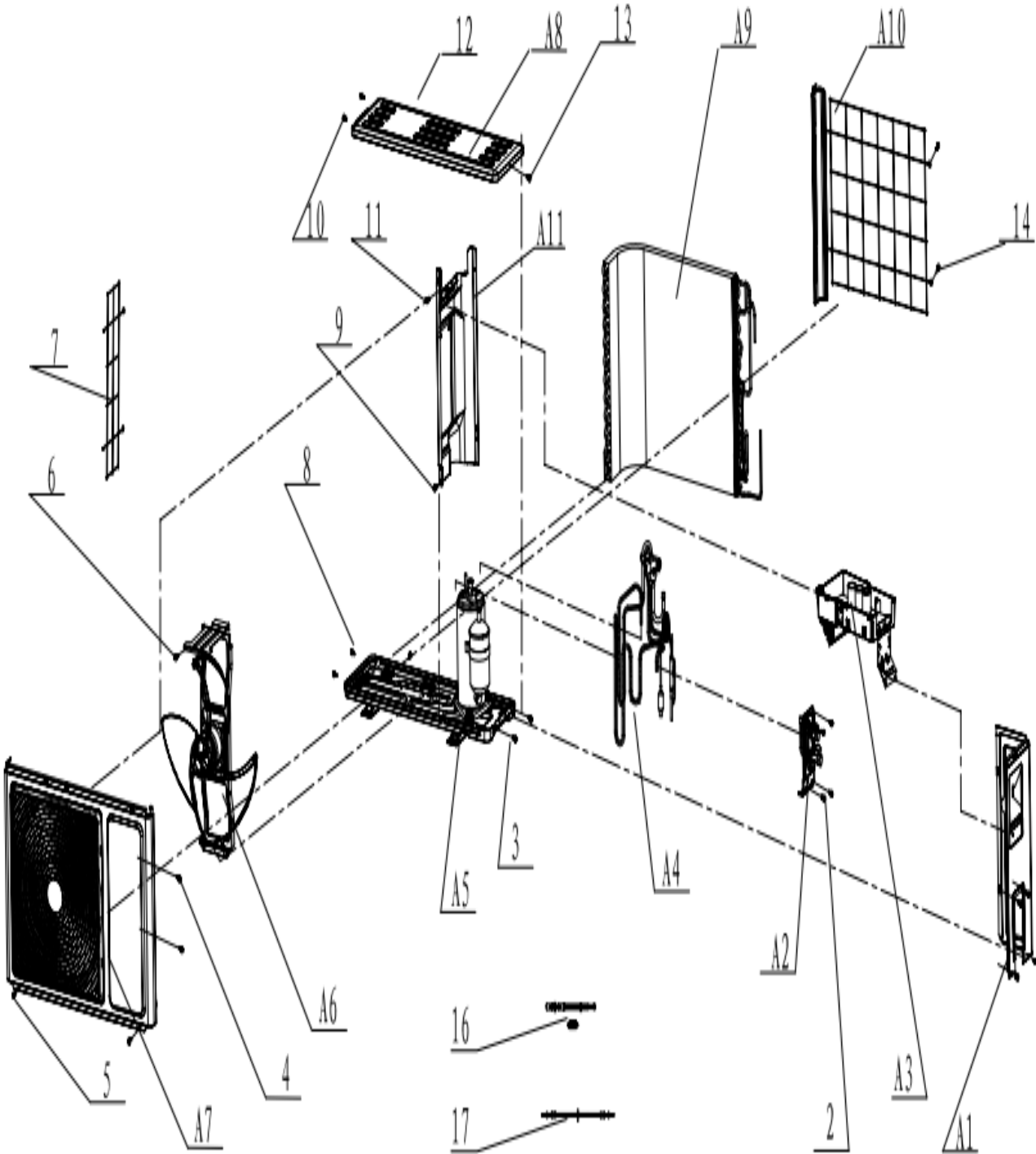

A1	right panel
A2	valve installation plate
A3	electric installation board
A4	pipe system
A5	base and compressor
A6	fan and motor support
A7	front plate subassembly
A8	top panel subassembly
A9	condenser subassembly
A10	pillar and back net
A11	Partition board
2	hexagon flange tapping screw
3	hexagon flange tapping screw
4	hexagon flange tapping screw
5	hexagon flange tapping screw
6	oblate tapping screw
7	left net
8	hexagon flange tapping screw
9	oblate tapping screw
10	hexagon flange tapping screw
11	oblate tapping screw
12	hexagon flange tapping screw
13	hexagon flange tapping screw
14	hexagon flange tapping screw
15	Electric heating belt
16	Electric heating belt

CS-35V3A-H5S

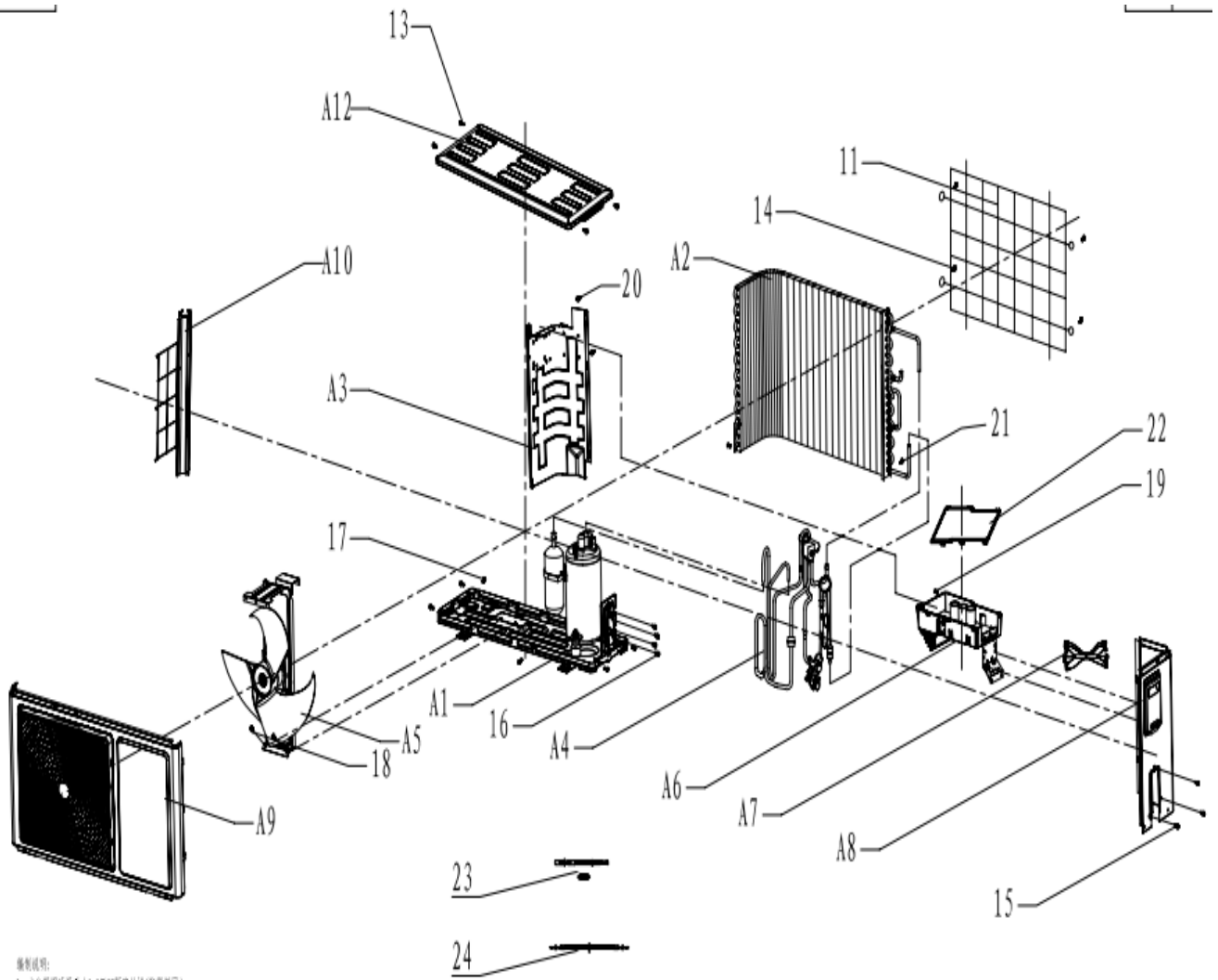

爆炸说明：
 1. 本分解图按大小1:3比例放大并绘(除原样外)；
 2. 本分解图是通用版本，具体到每个款式或机型时可能会有一些差异。

A1	base and compressor condenser subassembly
A2	
A3	Partition board
A4	pipe system
A5	fan and motor support
A6	electric installation board
A7	connecting line
A8	right panel
A9	front plate subassembly
A10	left net and pillar
11	back net
A12	top panel subassembly
13	hexagon flange tapping screw
14	hexagon flange tapping screw
15	hexagon flange tapping screw
16	hexagon flange tapping screw
17	hexagon flange tapping screw
18	oblate tapping screw
19	oblate tapping screw
20	oblate tapping screw
21	oblate tapping screw
22	top of electric installation board
23	Electric heating belt
24	Electric heating belt

E. Components fault and test methods

1. Ordinary compressor

1). Ordinary test (power off)

Testing method:

Check the compressor by eyeballing first. If there has burnt vestiges on the surface of compressor or the compressor gives out the bad smell, the reason mainly is that the winding is burnt. If the compressor terminal is burnt, mostly it is caused by the heavy current or the bad contact.

2). Resistance test

- ①.Short circuit: Measure resistance of each winding by universal meter, if the resistance value is lower than the standard, the winding may short circuit.
- ②.Open circuit: Measure resistance of each winding by universal meter, if the resistance value is infinite, the compressor winding may open circuit.

3). Electric leakage & insulation test

Measure resistance between the points of winding and other part of compressor by universal meter, if the resistance value is infinite, means no electric leakage and the insulation is perfect. If the resistance value is tiny or zero, electric leakage may exist in compressor or insulation material may be aged or broken.

2. AC motor of indoor and outdoor unit

1). General inspection

Testing method: In the case of non-power, twist motor rotor by hand, meanwhile shaking motor. checking is there any rust, whether blocked.

Fault judgement: If the motor rotor can't twist, that means the motor blocked. when shaking motor, there should be no abnormal noise, if the noise of inside the motor is small, it means motor shaft loose. if the noise of inside the motor is big, it means there is sundries inside of motor or electrical components loose.

2). DC resistance

- (1) Turn-to-turn short circuit: measure entire winding resistance by multimeter, if the difference between measured value with standard value is larger, it means turn-to-turn short circuit.
- (2) Opencoil: measure entire winding resistance by multimeter, if the resistance is ∞ , means opencoil.

3). Electric leakage & insulation test

Measure resistance between the points of winding with other part of motor by universal meter, if the resistance value is infinite, means no electric leakage and the insulation is perfect. If the resistance value is tiny or zero, electric leakage may exist in motor or insulation material may be aged or broken.

3. General Electric control panel(PCB)

1). Test method for common electronic component,

- (1) SCR: measure resistance between control electrode and positive electrode by multimeter, model Z47 is 20Ω to 400Ω , BT131 is $1.4K \sim 1.7K$, if the resistance is too large or too small, means not normal. And if the resistance between other electrode is infinite, means SCR damaged.
- (2) Check the voltage between input terminal and output terminal. if input voltage is ok and did not have the output voltage, need to replace the relay.
- (3) Optocoupler: the red pen connect the first leg of optocoupler, black pen connect the second leg. if the forward Resistance is about $1K$, and the resistance between other feet is infinite, means optocoupler damaged.
- (4) Transformer: primary coil resistance is $400\Omega \sim 1000\Omega$, Secondary coil resistance is $15\Omega \sim 40\Omega$, transformer damaged if deviation is big.

- (5) Temperature protective tube, varistor: resistance of protective tube should be 0Ω , that is, resistance of varistor should be infinite.
- (6) Main Chip: check the working voltage (5V) and voltage of reset feet and crystal oscillator, and then check peripheral components Step by step.
- (7) 2003(IC): 2003 is an inverter, in the working condition, input and output potentials are always contrary,.
- (8) Diodes: choose "diode" from multimeter, then the red pen connect positive pole, black pen connect negative pole, the resistance should be a few hundred ohm.the reverse resistance is infinity, otherwise diode is bad.
- (9) Transistor:
- ①: NPN transistor: choose "diode" from multimeter,red pen connect base、 black pen connect other two feet. and the resistance should be a few hundred ohm, otherwise the transistor damaged.
 - ②: PNP transistor: choose "diode" from multimeter,black pen connect base、 red pen connect other two feet. and the resistance should be a few hundred ohm, otherwise the transistor damaged.
- (10) Infrared Receiver Module: choose "diode" from multimeter,black pen connect power pin、 red pen connect other two feet. and the resistance should be a few hundred ohm, otherwise the transistor damaged.
- (11) Crystals: check voltage of crystals.the normal voltage is 2.1 V - 2.5 V, otherwise the crystals damaged.

2). Charged detection:

- (1) Connect PCB with Test-bed.check mode、 wind speed、 temperature and so on according to the remote control and control panel. PCB should receive signal accurately and correctly, and indicator light should feedback correctly or check whether has the correct output signal by a multimeter(such as: compressor、 fan、 four-way valve、 electrical heating、 step motor、 synchronous machine、 negative ion、 High voltage generator、 Dc decelerating motors.)
- (2) Each function control key should be flexible,
- (3) For liquid crystal display or fluorescence display,character should be clear and correct; There should not have the ghosting,brightness blance. Light board display normally, have no obvious Unnormal flicker.
- (4) step motor should be able to rotate;;
- (5) For the PCB with self-test function,press the self-test button, and then enter the self-test program.the output should be consistent with the design requirements,no procedures chaos or system halted.

3). Common fault detection

- (1) Unit doesn't work
 - a). Check whether input and output voltage of the transformer is normal (input AC220V, Output AC10V ~ 14V), if no problem,then check the next step;
 - b). Check whether "three-terminal voltage regulator 7805" is normal, if no problem,then check the next step;
 - c). Check whether the voltage of crystal oscillator is normal (2.1V-2.5V), if not, replace crystal;
 - d). If all above are normal,then replace the main chip.
- (2) Display bad or indicator light does not shine

Showing bad or light does not shine

 - a). Check whether the voltage of display board is normal (5V);
 - b). Check whether the resistance of display lamp is normal(light-emitting diode forward resistance is a few hundred ohms,)
 - c). check whether chip is cold solder joint, short circuit, or replace the chip.
- (3) Buzzer does not ring or abnormal:
 - a). Check whether the voltage of Buzzer is normal(about 12V),if normal,then check the next step ;

- b). Check whether the Buzzer is noiselessly..
- (4) Not receive or receiving is insensitive
- Check whether the wire of receiver is normal, or replace the connecting wires;
 - Check whether the voltage of receiver is normal(5V), or check the power supply circuit;
 - Check whether the receiver is normal.if normal,check whether the main chip is normal, otherwise, replace it.
- (5) Sensor failure
- Check whether the voltage of room temperature sensor and pipe temperature sensor is normal (make sure at the same temperature conditions,the voltage difference between these two sensors can not be greater than 0.1V, otherwise need to replace).
 - take down the sensor and measure the resistance, its resistance should be within standard deviation.
- (6) Indoor fan failure
- Check whether capacitance of fan is the same with nominal value.or replace the capacitor or check the next step.
 - For the tap fan,check voltage of high, medium and low wind relay.the normal voltage is DC12V.
 - For the tap fan,check whether the relay is normal.or may replace relay;
 - Check whether the AC power supply circuit is normal, or replace related devices.
 - For the PG fan,check whether SCR (C1815) is cold solder joint, loose, this circuit is normal or not.
 - For the PG fan,check whether voltage of SCR (C1815) is normal (Point C is about 0.3V,Point b is about 0.7V ,point e is 0V), or replace the C1815.
- (7) Step motor does not run or not good at running.
- Check whether solder joint of step motor is cold solder joint, loose and short-circuit for rosin, the main chip, the output voltage of control pin is about 2V,or check whether the main chip is normal or checking the next step;
 - Check 4-pin voltage which connect the step motor with 2003 is normal(10 ~ 12V), or check the 2003 or the connecting wire.
 - check whether the connecting wire of step motor and the motor is normal.
- (8) The relay does not work
- Check whether the voltage of the relay coil is normal (usually about 12V), otherwise check whether the relays is normal or checking the next step;
 - Check whether the relay is good, otherwise replace of relay;
 - Check whether the output pin of the main chip is high (5V), or check whether the main chip is normal or checking the next step.
 - Check whether the power supply circuit, transformer input and output voltage is normal,or checking the next step;
 - Checking whether the piezoresistor and temperature insurance are normal.(the resistance of piezoresistor is infinite.the resistance of temperature Insurance is 0) otherwise, check related componentsthe or checking the next checks;
- (9) Key is invalid
- Check whether the output pin of the button is normal, or replace;
 - Check whether the voltage of display board is 5V, otherwise, check the power supply circuit or connecting wire;
 - If all above are normal, check whether the main chip is normal, or replace the main chip.

4). Electric control panel detection

- ① red power indicat(LED1) is not bright:

- a). Check whether the LED1 is damaged, if damaged, please replace the diode;
 - b). Check whether the input and output voltage of the 7812 and 7805 is normal (7812 input 14V, output is about 12V, 7805 input 12V, the output 5V), if damaged, replace the related device or check downward;
 - c). Check whether the bridge rectifier diodes D1-D4 is normal, if the damaged, please replace related diode;
 - d). Check whether the power supply transformer of input and output is normal (input is about AC220V, the output is about AC14V), if it is damaged, replace the transformer.
- ② Green light LED2 does not shine or the phase sequence protection
- a). Check whether the light-emitting diode LED2 damaged, if not normal, then the replace the light-emitting diode;
 - b). Check whether the Q5 (9014) collector voltage is normal, if not normal, then the replace 9014;
 - c). Check whether the relay RY3 is normal, if not normal, then the replace the relay;
 - d). Check whether the resistance of the R7-R10 is normal, if not normal, then the replace the related resistance;
 - e). Check whether the phase sequence of the three-phase power supply is normal, if not, then the replace phase sequence.
- ③ No-voltage for over-current detection circuit
- a). Check whether the rectifier diodes D5-D8 is normal, if not normal, replace related diode;
 - b). Check whether the current transformer L1 is normal (resistance of ③ ④ foot should be around a few hundred ohms), if abnormal, replace it.
- ④ Over-current protection too long or too short.
- Check whether capacity of capacitance E3, E6 is normal (the normal over-current protection is about 20s ~35s), replace if it is not normal,
- ⑤ Appear over-current protection
- a). check whether the integrated block LM311 (7) feet IC3 is normal, if not normal, check IC3. if damage, replace it,
 - b), check whether triode 9012 is normal. if abnormal, replace it,
 - c), check the voltage of over-current relay coil is normal (about 12V), if it normal, check whether the relay damage.
- ⑥ no defrost signal temperature signal (defrosting relay can't break)
- a), check whether the temperature sensor is normal (measure sensor resistance), if the resistance is too large or too small or even infinite, or 0Ω , then replace sensor;
 - b), check whether the voltage of the defrost relay coil is normal (about 12V), if it's normal, check whether the relay damage.

4. Capacitor

①. Appearance inspection

Testing method:

Visual inspection whether the appearance of capacitor expansion, burst. if it was, that means the capacitor fail.

②. Check by open circuit

Testing method:

Check the capacitance by multimeter, if the pointer could swing to the right at once, then the pointer slowly reset to 0. that means the capacitance is no problem. if the pointer does not

move or do not reset, means capacitance is open circuit, electrolyte dry, or short-circuit

③. Capacitance breakdown, leakage of electricity

Testing method:

Check the capacitance by multimeter, if the pointer could then the pointer can't move. that means the capacitance is breakdown or leakage of electricity

④. Loss tangent inspection (as understanding project)

Judge standard:

run about 10 minutes, check surface temperature of capacitance. If the surface temperature exceeds the ambient temperature about 15 °C, that means loss tangent has exceeded the limit value 0.0018.

⑤. Check capacitance

check by pointer type multimeter: if the pointer oscillation amplitude is bigger than the standard capacitance, that means capacitance has been attenuated.

Digital Multimeter: check by Cx interface, the capacity should not exceed the nominal capacity of $\pm 5\%$.

⑥. Insulation inspection

Testing method:

normally, the resistance of capacitance is ∞ , if the number of resistance is thousands of ohms or greater, that means capacitance is no problem. if the resistance is smaller or 0, that means capacitance has been damaged, should be immediately replaced.

5. Transformer

1). Visual inspection

Check whether the appearance of transformer burnt phenomenon, check whether has the burnt transformer smell. If the appearance of burnt yellow phenomena or had burnt smell, transformer winding is bad.

2). Check on running

Testing method:

make transformer running under load (which can run with PCB), should be running smoothly, there shouldn't be unusual noise. if there is unusual noise, it is multi-electromagnetic noise.

3). Electrical Characteristics

(1) No-load characteristics

As for the power supply 220V/50Hz, 220V/60Hz, 240V/50 Hz, power 5 ~ 8W transformer primary load current $\leq 20\text{mA}$; power supply 115/60Hz; power 5 ~ 8W of the transformer primary No-load current $\leq 35\text{ mA}$; no-load output voltage does not exceed rated voltage +10%.

(2) Load Characteristics

transformer at rated load conditions; the error of the secondary coil voltage should not be greater than the requirements in Table 1;

4). Output power

(1) Measured current and voltage with the multimeter, and then according to $P = UI$, the output power should not exceed transformer nominal requirements of $\pm 8\%$, if you exceed this requirement, you can determine the transformer's power attenuation.

(2) According to $P = U^2/R$, the output power shall not exceed the transformer nominal requirements of $\pm 8\%$, if you exceed this requirement, you can determine the transformer power attenuation.

5). DCR

(1) turn-to-turn short circuit:

check by multimeter, select the appropriate range, measure the resistance of transformer winding,if the deviation between real resistance with the standard resistance is great,that means the inter-turn short circuit and outlet the open circuit.

(2) Coil Open circuit:

check by multimeter, select the appropriate range, measure the resistance.if the resistance is ∞ , that means transformer coil open circuit or open circuit.

6). Insulation inspection

(1) insulating property between the shell and the iron core

Testing method:

check by multimeter, select the appropriate range, measure the resistance.if the resistance is ∞ or tens of thousands of ohms,means insulating property is good.if the measured resistance of the smaller or 0,means core screen has been destroyed.

(2) insulation between the windings

Testing method:

check by multimeter, select the appropriate range. one pen contacts with the transformer primary,the other contacts with secondary output transformer.if the resistance is ∞ or tens of thousands of ohms,means insulating property is good.if the measured resistance of the smaller or 0,means core screen has been destroyed.

6. Remote control

1). Visual inspection

(1) injection parts should be no deformation, no mask loose, tilt phenomenon.

(2) The battery should be in a good elasticity with no rust.

(3) liquid crystal display without bubbles,display clear, correct, not more paragraphs, , ghosting and black.

2). Function test

The battery into remote control, LCD display should clearly show the content (non-LCD display does not check this). The receiver should be able to receive the instructions accurately.

3). Common fault

(1) Key failure

Testing method

make sure the unit running, installed battery to remote control, press various function keys.

Fault judgement

a). If multiple buttons are not work,the main reason is for the bad chip.

b). If sometimes normal, and sometimes fail, then the main reason is the underlying part has a impurity.

(2) No emission signal

Testing method:

make sure the unit running, installed battery to remote control, press various function keys.

Fault judgement

If the remote control without signal, but the display and other functions are normal,then most of the reason is that a bad emission tube. If the display is not normal, normally chip damage.

(3) Testing method:

make sure the unit running, installed battery to remote control, press various function keys.

Fault judgement

If the remote control is neither transmit nor display, means chip resistors, chip capacitance, crystal 1 (iron crystal) and other damage, If you press reset button, remote control full screen then back to not show the status, then the most for crystal 2 (ceramic oscillator) is damaged.

(4) Show insufficiency

Testing method:

make sure the unit running, installed battery to remote control, press various function keys.

Fault judgement

If the remote control showing the insufficiency phenomena that are mostly liquid crystal rupture, leakage and other causes.

4). Electrical properties

(1) tandem the ammeter with remote control, in the DC 3.0V voltage ,if unit can not launch a signal,in the unit with liquid crystal display,the quiescent current $\leq 70\mu\text{A}$, in the absence of liquid crystal display , the quiescent current $\leq 20\mu\text{A}$.

(2) under the voltage of 2.6V,remote control should be able to work properly. In not more than 80% of the rated voltage (2.4V),the LCD of remote control should be able to clearly show.

7. Four-way valve

1). General inspection

Visual inspection: pull coil of each power cord, wires should be no break phenomenon;

2). DCR

(1) turn-to-turn short circuit:

Check by multimeter, select the appropriate range, measure the resistance. If the resistance smaller than the standard resistance.it means four-way valve turn-to-turn short circuit.

(2) coil Open circuit:

Check by multimeter, select the appropriate range, measure the resistance.if the resistance is ∞ , it means four-way valve open circuit.

3). Insulating property

Testing method:

check by multimeter, select the appropriate range. one pen contacts with input terminal,the other contacts with body.if the resistance is ∞ or tens of thousands of ohms,means insulating property is good.if the measured resistance of the smaller or 0,means core screen has been destroyed.

4). Run on power

Testing method:

connect the four-way valve and the electrical components,connected to rated power; change the mode between cooling and heating mode,check whether the four-way valve could correctly change.

Fault judgement:

if the four-way valve could not change correctly, means four-way valve bad or wire partial short-circuit fault.

8. Step motor

1). General inspection

Testing method:

Visual inspection: check whether the appearance of step motor is burnt, rust. If have,that means the winding of motor is broken.In the case of non-power,hand knob step motor's output shaft,if there exist strange noise,that may be caused by driving wheel not matching or loose for

connecting piece.

2). Check torque

Self-positioning Torque:

under the action of this torque, step motor should not lose, not jitter, non-skid.

3). Resistance test

① short circuit: Measure resistance of each winding by universal meter, if the resistance value is lower than the standard, the winding may short circuit.

② open circuit: Measure resistance of each winding by universal meter, if the resistance value is infinite, the compressor winding may open circuit.

4). Check on running

Testing method:

make sure step motor running with load, there shouldn't be unusual noise. if there is unusual noise, it is caused by rust or wear. If the step motor does not work, most is due to open coil, short circuit, or rust.

5). Insulating property

Testing method:

check by multimeter, select the appropriate range. one pen contacts with input terminal, the other contacts with body of step motor. if the resistance is ∞ or tens of thousands of ohms, means insulating property is good. if the measured resistance of the smaller or 0, means core screen has been destroyed.

6). Electrical performance checking

Testing method:

use needle nose pliers or similar tool clamp output shaft of the motor, rotate it clockwise. at the same time, choose AC 20V voltage, then connect two pens with step motor input end. after rotating the output shaft there should be clear voltage shows on multimeter.

9. Synchronous motor

1). General inspection

Testing method:

Visual inspection: check whether the appearance of synchronous machine is burnt, rust. If have, that means the winding of motor is broken. In the case of non-power, hand knob output shaft, if there exist strange noise, that may be caused by driving wheel not matching or loose for connecting piece.

2). Resistance test

① short circuit: Measure resistance of each winding by universal meter, if the resistance value is lower than the standard, the winding may short circuit.

② open circuit: Measure resistance of each winding by universal meter, if the resistance value is infinite, the compressor winding may open circuit.

3). Testing method:

check by multimeter, select the appropriate range. one pen contacts with input terminal, the other contacts with body of step motor. if the resistance is ∞ or tens of thousands of ohms, means insulating property is good. if the measured resistance of the smaller or 0, means core screen has been destroyed.

4). Check on running

Testing method:

make sure synchronous machine running with load, there shouldn't be unusual noise. if there is unusual noise, it is caused by rust or wear. If it does not work, most is due to open coil, short circuit, or rust.

5). Torque checking

Testing method:

make sure the motor running by rated power, use needle nose pliers or similar tool clamp output shaft of the motor till making the motor stop.

Fault judgement:

At rated voltage, frequency, braking torque of synchronous machine should be $\geq 0.345\text{Nm}$, if the output shaft of the torque is less than 0.345Nm , can be found the torque is not enough, can not bring the throttle to run.

6). Electrical performance checking

Testing method:

use needle nose pliers or similar tool clamp output shaft of the motor, rotate it clockwise. at the same time, choose AC 20V voltage, then connect two pens with step motor input end. after rotating the output shaft there should be clear voltage shows on multimeter.

10. Outdoor electrical heating cable and crankshaft electric heating cable:

- 1). **Outdoor electrical heating cable is controlled by the outdoor environment temperature:** Starts below 0 degree, closes after the temperature up to 3 degree. As long as the machine is with electricity connected, the outdoor electrical heating cable will keep to determine whether it is needed to work or not.
- 2). **Crankshaft electric heating cable is controlled by the outdoor environment temperature:** Starts below 0 degree, closes after the temperature up to 3 degree. As long as the machine is with electricity connected, the crankshaft electrical heating cable will determine whether it is needed to work or not.
- 3). When in test mode, the outdoor electrical heating cable and crankshaft electrical heating cable will not start.

F. Failure display

Check parts	Serial number	Malfunction content	Indoor unit display status		
			Code	LED(Indoor unit without the nixietube)	
				Running lamp flashing frequency n	Timing lamp flashing frequency n
Indoor parts	1	The communication faults in the indoor and outdoor units	F1	1	lighten
	2	Indoor ambient temp. sensor fault	F2	2	lighten
	3	Indoor coil temperature sensor fault (Include: Inlet, middle of pipe, outlet.)	F3	3	lighten
	4	Indoor fan fault	F4	4	lighten
Outdoor parts	1	Outdoor module fault	F5	5	lighten
	2	Outdoor ambient temp. sensor fault	F6	6	lighten
	3	Outdoor coil temp. sensor fault	F7	7	lighten
	5	Compressor discharge temp. sensor fault	F9	9	lighten
	7	Compressor drive abnormal fault	FC	11	lighten
	10	Other fault	FF	14	lighten

Check parts	Serial number	Protection content	Indoor unit display status		
			Code	LED(Indoor unit without the nixietube)	
				Running lamp flashing frequency n	Timing lamp flashing frequency n
Indoor parts	1	Evaporator temp protection	P1	lighten	1
Outdoor parts	1	Overheat, over current protection of inverter module	P2	lighten	2
	2	Over current protection	P3	lighten	3

	3	Compressor discharging temp. protection	P4	lighten	4
	6	Power supply over current/ over voltage protection	P7	lighten	7
	9	High temp of condenser protection	PA	lighten	10
	10	High temp of outdoor ambient protection	PC	lighten	11

G. TROUBLE SHOOTING

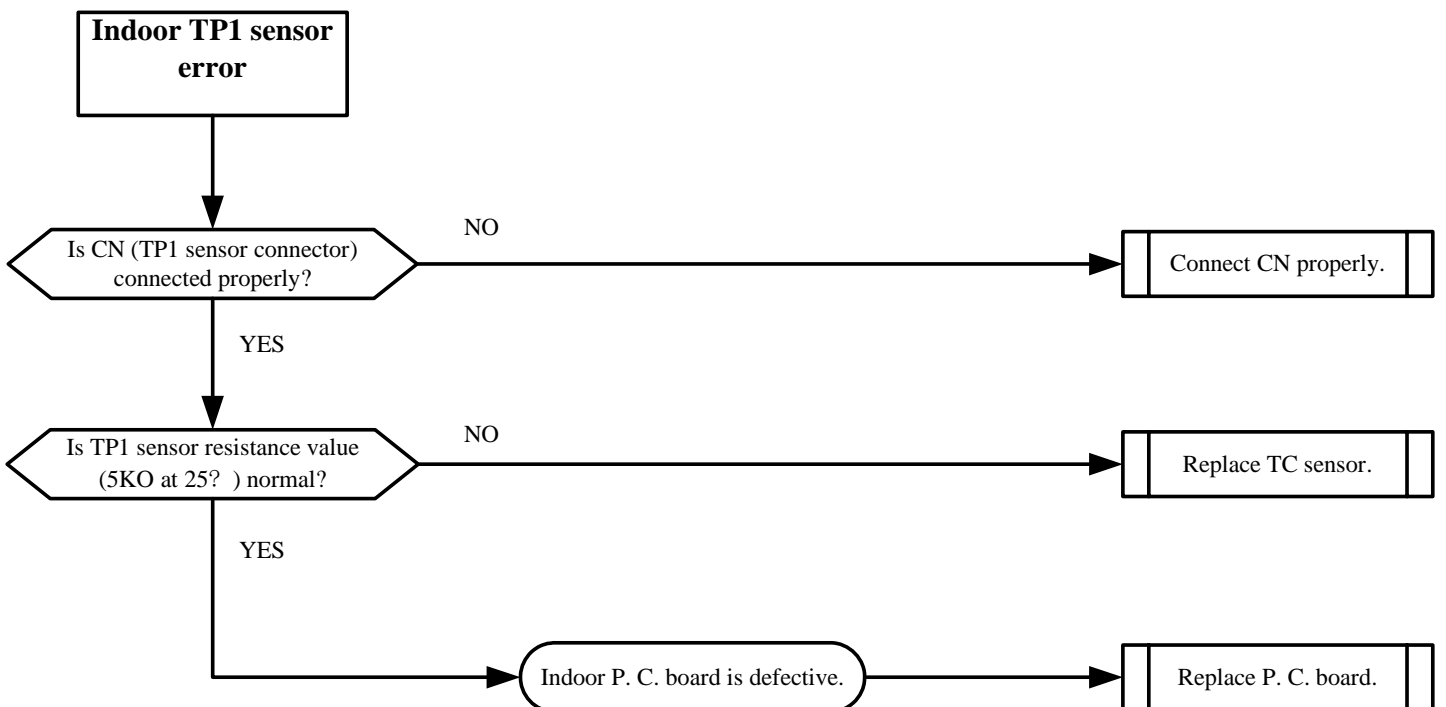
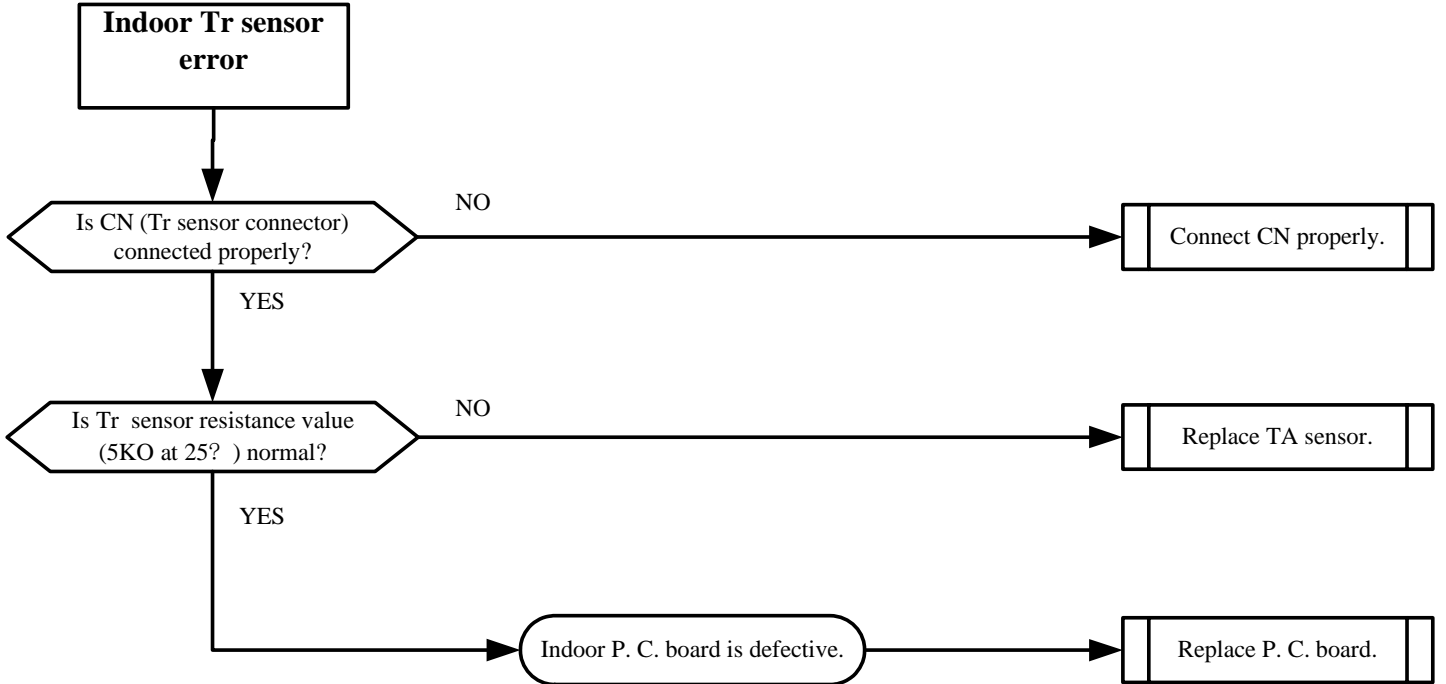

Only indoor fan motor does not operate.

<Primary check>

- (1) Is it possible to detect the power supply voltage (200-240V) between L and N on the terminal block?
- (2) Does the indoor fan motor operate in cooling operation?

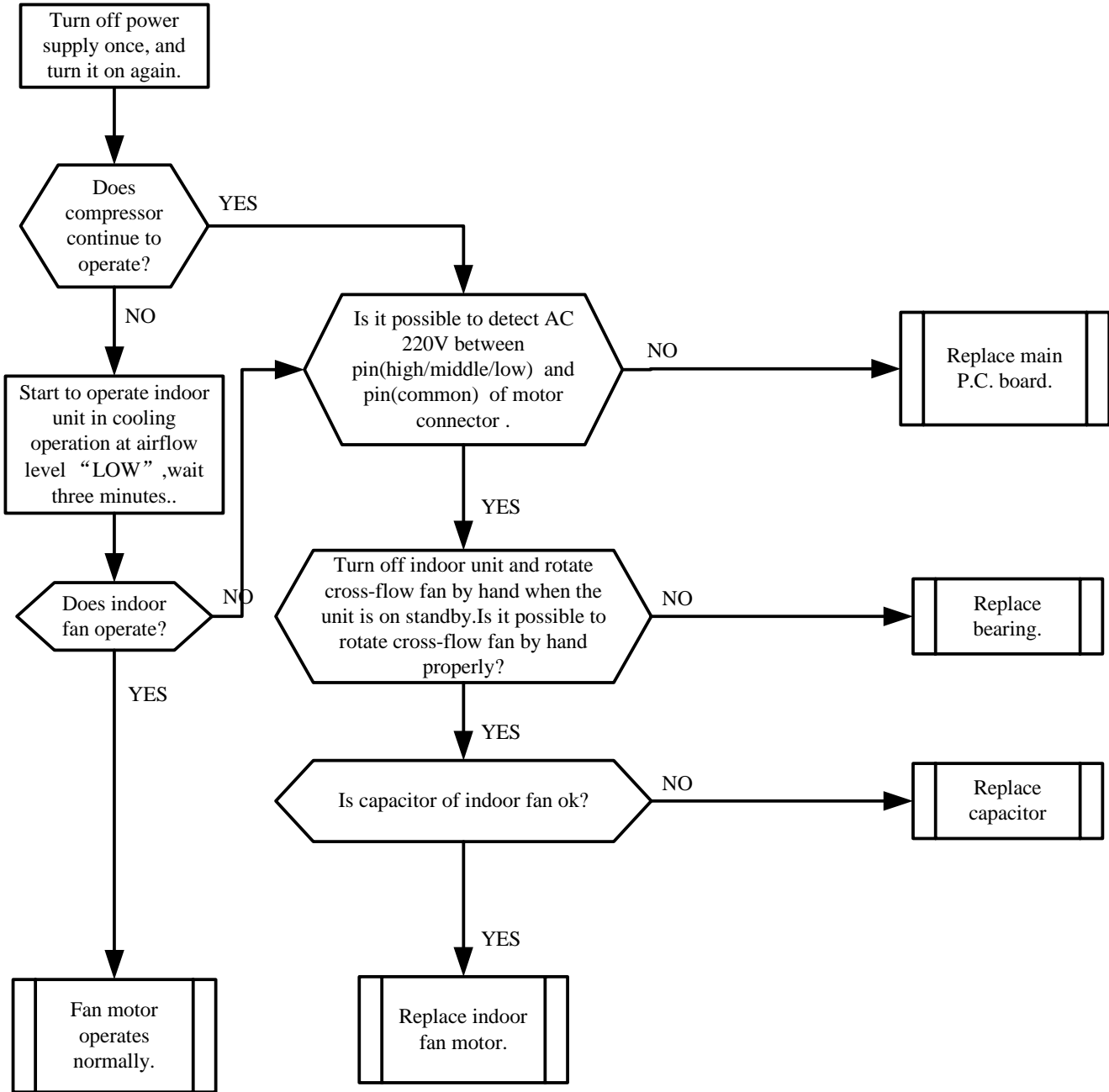

Compressor does not operate.

<Primary check>

- (1) Is the room temperature higher than the preset temperature in cooling operation?
- (2) Is the crossover cable connected properly?

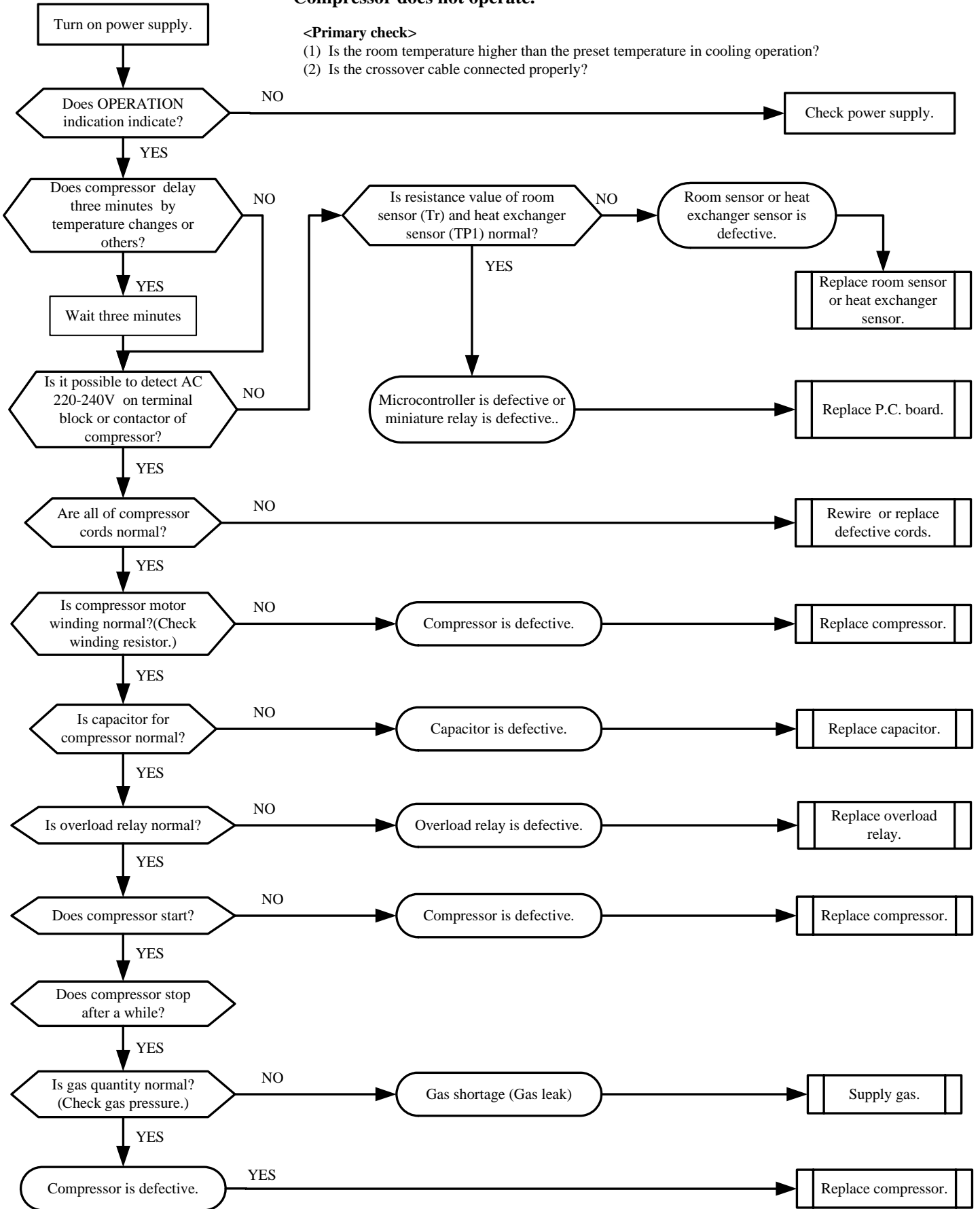

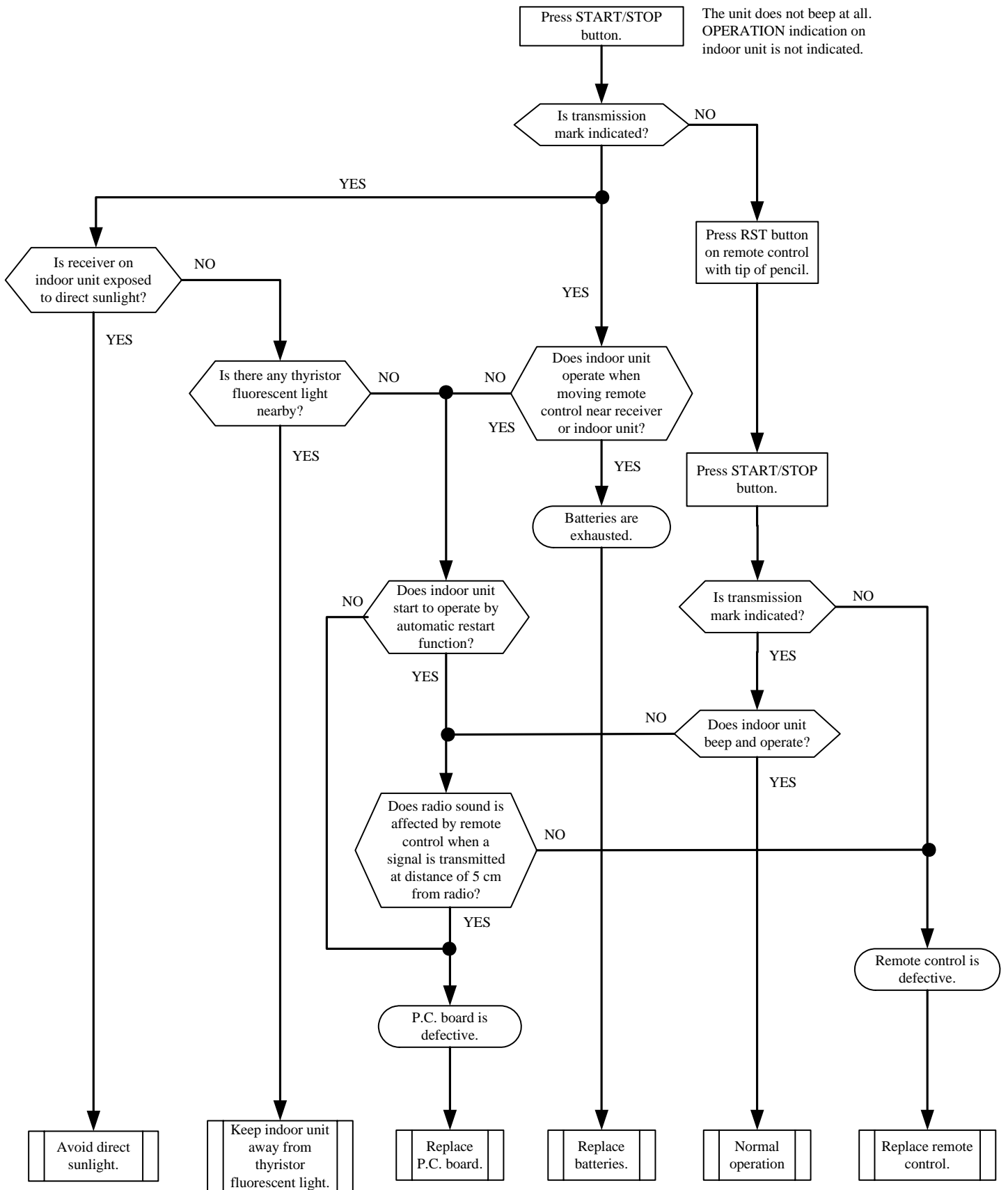

Trouble shooting

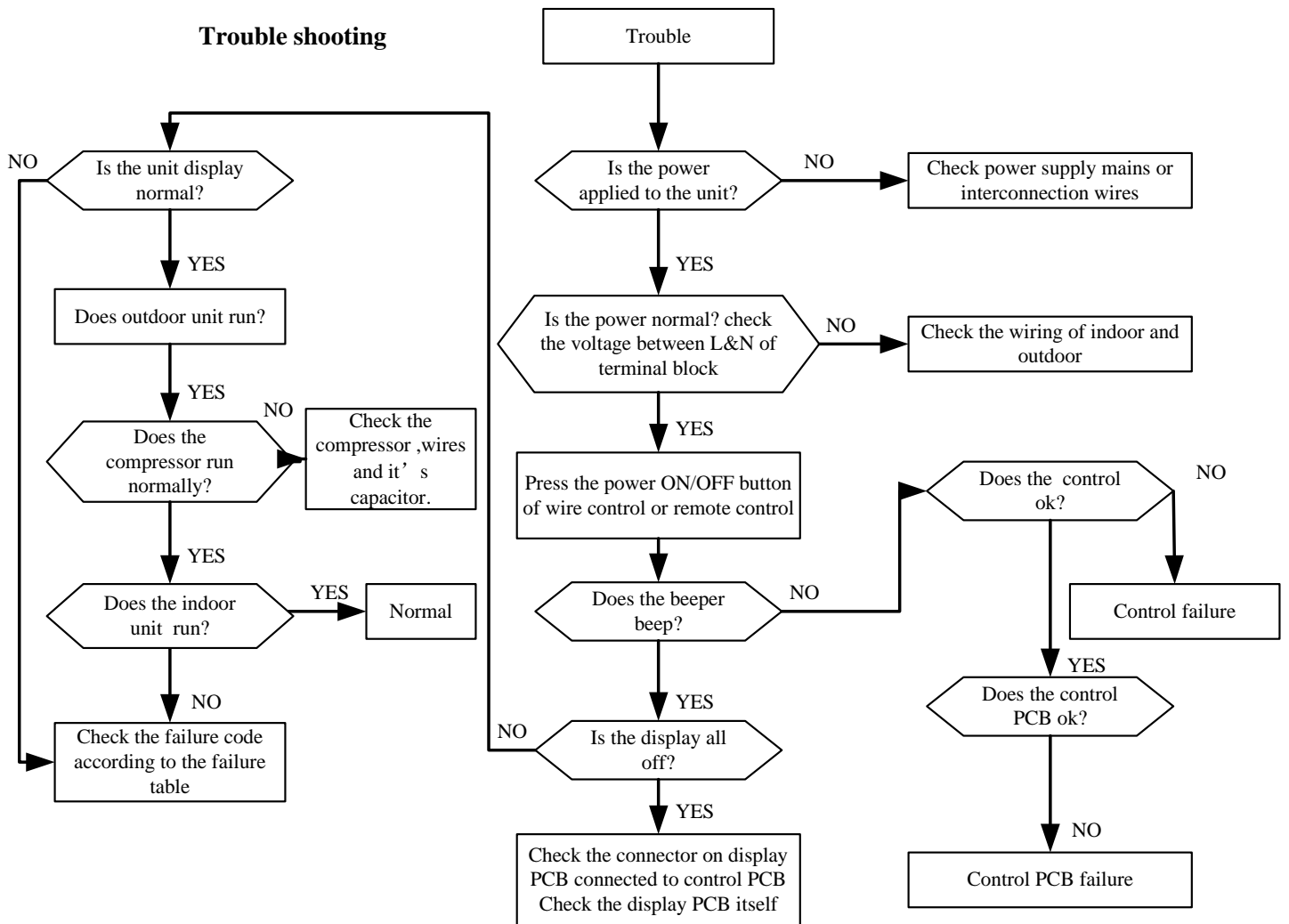

Indoor unit and outdoor unit don't operate

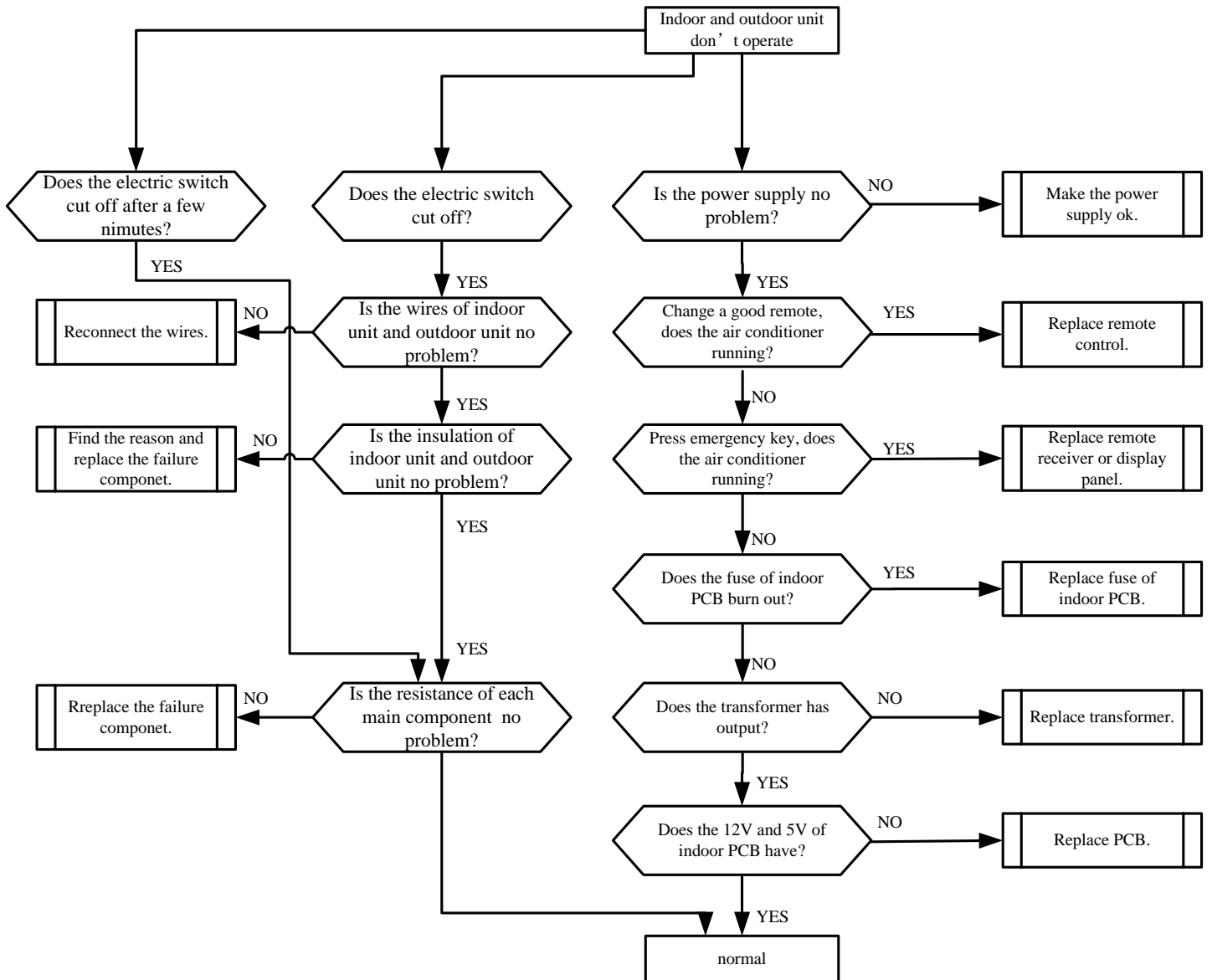

H. Usual failure analysis

No.	Fault	The possible reason	Solution
01	Not cooling well.	The room is too large ;the window or door is not closed.	Close the window and door
		Too many persons or heat source in room.	Reduce the heat source.
		The installed position of outdoor unit isn't good. Have insolation or not good in ventilation.	Reinstall the unit.
		The installed position of indoor unit isn't good. Bad in air circulation.	Reinstall the unit.
		The air filter is dirty or blocked.	Clean this air filter.
		The system blocked.	Check capillary tube, strainer etc. repair or replace them.
		The refrigerant leakage.	refill up refrigerant after checking the leak source.
		The set temperature is too high .	reduce the set temperature.
		The condenser blocked by dust or others.	clean the dust and dirt.
		Too much quantity of refrigerant.	take the redundant refrigerant out.
		Blockage in airinlet or air outlet.	Clear the obstacles.
		Air mixed in refrigerant.	refill the refrigerant.
		High outdoor temperature.	
		The indoor or outdoor fan motor is running slow	Change this indoor or outdoor fan motor
		The compressor suction or venting capability is very poor	Change this compressor
Four-way valve slight mixes up	replace it		
other			
02	Can not cool.	The fan doesn't run (motor or capacitor of fan failed, Poor contact for the line of capacitor, line fault. The motor relay and drive circuit is fault)	Check. Repair and replace.
		The compressor doesn't work(the voltage is too low ,overload, wiring error. The compressor failed. The capacitor of compressor failed. the capacity of electric fence isn't enough.)	Check. Repair and replace.
		The refrigerant leaked completely	refill up refrigerant after checking the leak source.

		The system blocked completely	Check capillary tube, strainer etc. repair or replace them.
		other	
03	Not heating well.	The room is too large ;the window or door is not closed.	Close the window and door
		The set temperature is too low.	Heighten the set temperature.
		The air filter is dirty.	Clean this filter.
		The refrigerant leaked.	refill up refrigerant after checking the leak source.
		The system blocked slightly	Check capillary tube, strainer etc. repair or replace them.
		The outdoor temperature is too low.	
		The A/C can't melt down frost or	Replace this sensor or move the sensor to the thickest position of frost
		The indoor or outdoor motor speed is lower	Replace this fan motor
		The compressor suction or venting capability is very poor	Replace this compressor
		Four-way valve slight mixes up	Let the four-way valve moving continually. Replace the four-way valve if it can't move
		The capillary valve has been blocked.	Replace this capillary valve
			other
04	Can not heating.	The fan doesn't run (motor or capacitor of fan failed, Poor contact for the line of capacitor, line or PCB fault.).	Check. Repair and replace.
		The compressor doesn't work(the voltage is too low or high, overload, wiring error. The compressor failed. The capacitor of compressor failed.the capacity of electric fence isn't enough.)	Check. Repair and replace.
		The refrigerant leaked.	refill up refrigerant after checking the leak source.
		The system blocked completely	Check capillary tube, strainer etc. repair or replace them.
		The compressor failed.	Replace compressor.
		The compressor is blocked	replace it
		The four-way valve failed and can't replace direction.	Check the circuit and replace the four-way valve.
		The PCB damaged and no output.	Replace PCB.

		The indoor temp-sensor has been damaged.	Replace this indoor tempensor
		Other	
05	The compressor doesn't work.	The compress connecting wire is loose	reconnect this line.
		supply voltage is too low.	install voltage regulator.
		The capacitor of compressor failed.	Replace this capacitor.
		The PCB failed	Check. Repair and replace this PCB.
		The compressor locked.	Replace this compressor.
		The compressor open circuit or short circuit.	Replace this compressor.
		The overload protector has been damaged	Replace this overload protector
		Other	
06	The AC can't turn on	No power in AC.	power connection.
		The remote have no power or damaged.	replace the battery or remote.
		The electric outlet failed.	Replace electric outlet.
		missing phrase for supply voltage.	Match right power
		supply voltage is too low.	install voltage regulator.
		The main fuse burn-out.	Replace fuse.
		The voltage dependent resistor has been burst	Change this voltage dependent resistor
		This AC can't receive the remote signal because of receiving head or window failure	Repair or replace this receiving head or window
		poor contact for socket connector of PCB.	Check. Repair or replace this PCB.
		The transformer damaged.	Replace this transformer.
		The PCB damaged and no output.	Replace the PCB.
		Other	
07	Unit suddenly doesn't work after running some time.	Power failure.	Wait for the power supply
		fuse of power supply burn out.	Replace this fuse.
		poor contact for the plug.	Check repair and replace the plug and socket.
		Have set regularly shutdown.	Restart the A/C.
		The PCB has any trouble	Repair or replace this PCB
		electromagnetic interference	romove the plug and plug again ,restart
		Other	
		no refrigerant in system.	Please fill up refrigerant.

08	Can not heating and cooling.	The refrigerant leaked.	refill up refrigerant after checking the leak source.
		Disconnecting valve dosen't turn on.	Please turn on disconnecting valve.
		The system is blocked. For example the strainer or connect pipe.	Replace this parts which blocked.
		The compressor failed.	Replace the compressor.
		No air from the outlet	find out the cause ,replace the motor ,capacitor,PCB,or do other actions
		Other	
09	Noise and vibration is existent during running.	Electromagnetic noise from compressor.	Replace this compressor.
		Resonance between the compressor and other parts.	Add bumper block or adjust the position
		The indoor and outdoor motor rusted or electromagnetic noise.	Replace this motor.
		The cross flow fan collides with the slot basis	Reconfigure.
		The noise of the refrigerant moving.	Readjust the position of the H&L pressure pipe.
		The screw of outdoor unit is loose and caused the noise and vibration.	crew down this screw.
		The bearing of cross flow fan broke.	Replace the bearing.
		The cross flow fan collides with the foam or sponge	
		The pipe of outdoor unit contact with crust	make the pipes well,keep the suitable space(over 10mm)
		The noise come from synchronous motor, stepper motor, capacitance, transformer, reactor.	Replace them
		the indoor and outdoor air circulation channel is clogged, which generated noise.	Clear the sundries
		fan or blower damaged	Replace it
		Other	
		The drain pipe is jammed or broken.	Clear up the stem or replace a new pipe.
		The installation of evaporator and water receiving tank is not in place.	reinstall them
		The outlet part broke.	Paste new gland strip.

10	Water leakage of indoor unit	When bending tube of the evaporator collides with the PCB's wire, the condensed water would flow along the wire, and can't flow into the receiving water tank.	Please avoid contacting between the bending tube and the PCB's wire.
		A lot of evaporator fins fall down to lead to bad flow.	Renovate these faulty fins.
		The indoor unit didn't install correctly according to the requirement.	Please reinstall the indoor unit correctly.
		The damping rubber is shedding	Put again
		The drain pipe is shedding	Fix again
		The filter or evaporator is very dirty	Clean it
		refrigerant isn't enough, cause the evaporator ice, leak water after off	Refill refrigerant

I. User's Manual





Please read the "Instruction Manual" carefully prior to the use of your air conditioner so as to ensure proper operations.

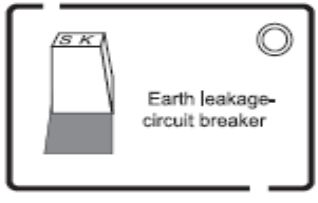
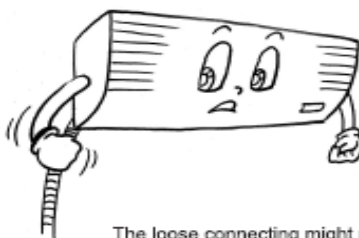
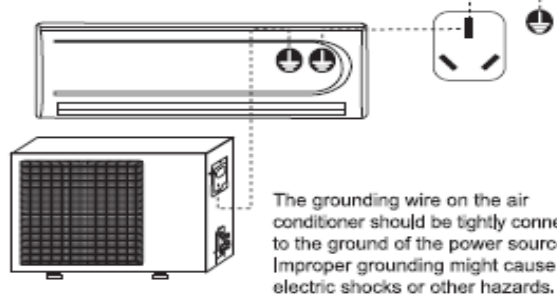



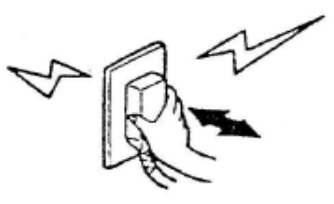



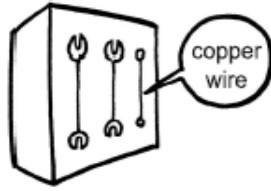



Instructions for Installation

- Make sure to have the professional after-sale service persons of our company or the authorized dealers to install the units before you use.

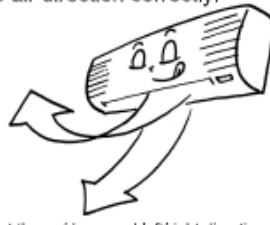
<p>1. The units are not to be installed at places where there might be leakage of combustible gases.</p>  <p>In case that the leaked gas accumulates around the units, there might occur the accident of fire hazards.</p>	<p>Make sure that the earth leakage-circuit breaker is installed.</p>  <p>Absence of the earth leakage-circuit breaker might lead to electric shock and some other hazards.</p>
<p>After the connecting of the wires between the indoor unit and the outdoor unit, check whether the connecting is loose or not by pulling the wire with a little force.</p>  <p>The loose connecting might result in fire hazard.</p>	<p>Make sure that the air conditioner is properly grounded.</p>  <p>The grounding wire on the air conditioner should be tightly connected to the ground of the power source. Improper grounding might cause electric shocks or other hazards.</p>

Instructions for Operation

<p>Never try to stop the operation of the air conditioner by pulling out the power supply line.</p>  <p>Such performance might cause electric shocks or fire hazards.</p>	<p>Do not connect the power supply line to an intermediate connector. Use of prolonged power line is strictly forbidden. Nor is it allowed to share the same plug connector with other electric appliances.</p>  <p>It might cause electric shocks, overheating, fire hazards or other accidents.</p>	<p>Do not press, stretch, damage, heat or modify the power line.</p>  <p>It might cause electric shocks, overheating, fire hazards, etc. If the power line wire is damaged or needs to be replaced due to some other reasons, please make sure to have dealer or the authorized maintenance people to do the replacement.</p>
<p>Do not operate the switch by wet hands.</p>  <p>It might cause electric shocks.</p>	<p>Before the connector is plugged in, please make sure that there is no dust on it and that it is plugged fully in place</p>  <p>If there is dust on the plug or if the plug is not in place, it might cause electric shocks or fire hazards.</p>	<p>Never use the fuse with incorrect capacity or any other metal wires.</p>  <p>The use of metal or copper wires for fuse might cause operational failures or fire hazards.</p>

<p>Try to avoid the sunlight and hot air from entering the room.</p>  <p>I'm scorched!</p> <p>During the cooling operation, curtains or window-blinds should be used to shade off the sunlight.</p>	<p>Try to minimize the generation of heat during the operation of cooling.</p>  <p>Place the heating sources out of the room.</p>	<p>Do not use combusting apparatuses in the air-conditioned room.</p>  <p>It might lead to the incomplete combustion of these apparatuses.</p>
<p>Do not place insecticides or paints and other flammable sprays near the air conditioner, or spray them directly at the air conditioner.</p>  <p>It might cause fire hazards.</p>	<p>When it is necessary to use the air conditioner and the combusting apparatuses in the same room, air ventilation has to be made from time to time.</p>  <p>Insufficient ventilation might lead to lack of oxygen or some other dangers.</p>	<p>Prior to the maintenance of the air conditioner, please cut off the power supply first. Never do the cleaning of the units when the fan is in high-speed operations.</p> 
<p>Do not insert sticks or bars into the air vents.</p>  <p>Dangerous!</p> <p>As the fan is in high-speed operation, the insertion might lead to accidents.</p>	<p>Adjust the air direction correctly.</p>  <p>Properly adjust the up/down and left/right directions of the air flow so as to get the even room temperature.</p>	<p>Do not keep exposed to the cool air for long time.</p>  <p>It might cause discomforts of the body, which is harmful to your health.</p>
<p>Do not clean the air conditioner with water.</p>  <p>It might cause electric shocks.</p>	<p>Do not attach, hang or stack articles on the air conditioner.</p>  <p>It might lead to the falling down of the air conditioner unit, which will result in accidents or injuries.</p>	<p>Check the supporting structures of the units carefully.</p>  <p>In case of damages, the supporting structures should be immediately repaired so as to avoid falling down of the unit, which might cause human injuries or other accidents.</p>
<p>Do not sit on the outdoor unit or place any other objects on it.</p>  <p>The falling down of the unit or the objects might cause human injuries and other accidents.</p>	<p>Do not use the following substances:</p>  <p>Hot water (over 40°C or 104°F) The use of hot water will deform the air conditioner or make it fade in color. Gasoline, paint diluent, benzene and polishing agents, etc. These substances will deform the air conditioner or cause scratches.</p>	<p>Pull out the plug when the unit is not in use for long time so as to ensure safety.</p>  <p>When the plug is to be pulled out, make sure that the switch of the air conditioner is turned off.</p>

Instructions for Removal and Repair

- When removal or repair is needed, please contact the dealer or authorized maintenance & installation people.
- In case of any abnormal occurrences (smell of burning), please stop the operation at once, cut off the power supply and contact the dealer or authorized maintenance people.

Remote controller

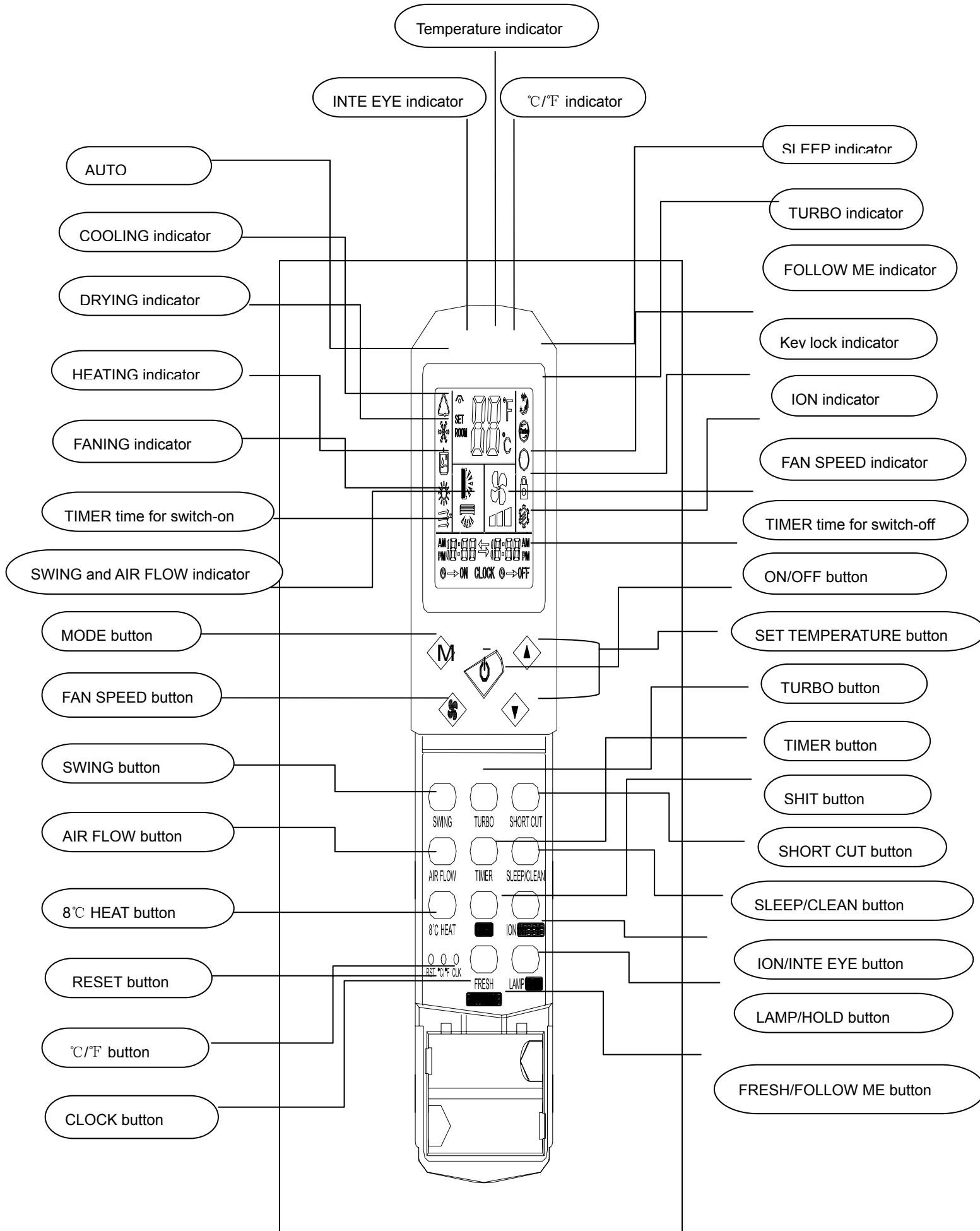

NOTE:

- Above figure shows all indicators for the purpose of explanation, but practically only the pertinent parts are indicated. When air-conditioner is cooling-only mode, the HEAT is for FAN. The INTE EYE function and FRESH function are not available for Nordic design model.
- When TURBO operation is selected, room temperature is not controlled with operation being continually. If you feel the room temperature is too cool or too heat, please cancel the TURBO operation.

Transmission procedure

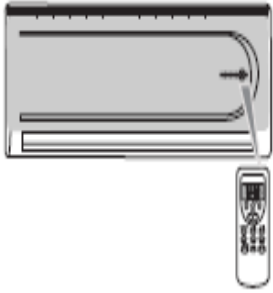











When each button on the remote controller is pressed with the remote controller pointing toward the air conditioner unit, signal is sent.

When the signal is received correctly, the receiving sound is emitted from the unit.

Use of remote controller

Operating machine in selected modes

1. Point the remote controller at the unit, press the ON/OFF button, then press the MODE button, select the needed mode: AUTO, COOL, DRY, HEAT, or FAN.
2. Press the SET TEMPERATURE button to increase or decrease the readings until the needed temperature is displayed. The room set temperature range is from 16°C-32°C (61°F-90°F).
3. Press the FAN SPEED button to choose the air rate you want: Low (display indicates “”), Med (display indicates “”), Hi (display indicates “”), Auto (display “” indicator flashing).
4. Press the SWING button to choose the up/down air flow direction you want: fixed wind (display indicates “”), swing (display “” indicator flashing). Natural flow (display indicates “”).
5. Press the AIR FLOW button to choose the left/right direction you want: swing (display “” indicator flashing), fixed wind (display indicates “”).
6. Press the ION button, display indicates “”.
7. Press the INTE EYE button, display indicates “”. This function is not available for Nordic design model.
8. Press the FRESH button, no indicator display on the screen. This function is not available for Nordic design model.

Button Operation

1. ON/OFF button: This button is used to start or close operation of the machine.
2. MODE button: This button is used to change the operation mode: AUTO, COOL, DRY, HEAT, FAN.
3. ▲ button: This button is used to increase the temperatures.
4. ▼ button: This button is used to decrease the temperatures.
5. AIR FLOW button: This button is used to select the left or right air flow direction, when press the in flap will swing or fix. (It just works on three-dimensional air-flow model.).
6. Swing button: This button is used to change the flap mode: natural flow, swing or fixed wind.
7. FAN SPEED button: This button is used to set air rate.
8. TIMER button: This button is used to set the timed switch on, the timed switch off, or timer setting cancellation.
 - Press the TIMER button for the first time, the hours setting flashing, indicates ▲ ▼ to set the hours for the timed switch-on.
 - Press the TIMER button for the second time, the minutes setting flashing, indicates ▲ ▼ to set the minutes for the timed switch-on.
 - Press the TIMER button for the third time, the TIMER setting will be implemented by following:
 - When previous two pressing of TIMER button for setting the timed switch-on, no press ▲ ▼ to adjust the hours and minutes, the setting of switch-on is canceled.
 - When previous two pressing of TIMER button for setting the timed switch-on, pressed ▲ ▼ to adjust the hours and minutes, the timed switch-on is set, and the signal is sent to the receiver.
 - Press the TIMER button for the fourth time, the hours setting flashing, indicates ▲ ▼ to set the hours for the timed switch-off.
 - Press the TIMER button for the fifth time, the minutes setting flashing, indicates ▲ ▼ to set the minutes for the timed switch-off
 - Press the TIMER button for the sixth time, the TIMER setting will be implemented by following:
 - When previous pressing of TIMER button for setting the timed switch-off, no press ▲ ▼ to adjust the hours and minutes, the setting of switch-off is canceled, no signal is sent to the receiver.
 - When previous pressing of TIMER button for setting of the timed switch-off, pressed ▲ ▼ to adjust the hours or minutes, the timed switch-off is set, the signal is sent to the receiver.
 - After finishing the setting of the timed switch-off, when you press TIMER button again, the setting of TIMER function (the timed switch-on or the timed switch-off) will be canceled.
 - After finishing the setting of TIMER function without pressing TIMER button again, the TIMER time will show on the display screen, clock digits will not show on the display screen. When press CLOCK button, the clock digits show on the display screen, but the TIMER time will show again on the display screen after releasing the CLOCK button.
9. TURBO button: This button changes to TURBO operation. Press TURBO button during COOL or HEAT operation, it does not work in AUTO, DRY and FAN mode. When you press, no icon show on the display screen and no signal

send to the receiver under AUTO, DRY and FAN mode. If the sleep function is set, the turbo function will be canceled.

10. CLOCK button (CLK): This button is used to set time. Press this button enters the CLOCK setting, after modification of the time by pressing ON-OFF button or pressing CLOCK button again to complete the time setting. Or complete the time setting when the flashing stops after 15 minutes.
11. SHORT CUT button: This button is used to fast switching the needed setting. Long press the SHORT CUT button, indicator “→”“←” flashing, to set the needed parameters (operation mode, temperature, fan speed, turbo, sleep, air flow etc.). After finishing the setting, press SHORT CUT button again, no indicator “→”“←” show on the display screen, the current setting parameters will be stored. Every short press the SHORT CUT button, the machine runs the memory setting. SHORT CUT button will not store the parameters of the function TIMER, CLOCK and HOLD.
12. 8°C HEAT button: This button is used to start or stop the 8°C HEAT function.
13. SHIFT button: This button is used to shift the function on the composite buttons (ION/INTE EYE, SLEEP/CLEAN, FRESH/FOLLOW ME, LAMP/HOLD). Press SHIFT button, the right arrow indicator flashing, the second button function is available when you press the composite button. When you press SHIFT button again or no press any button in 30 minutes, the right arrow indicator stops flashing, then the first button function is available when you press the composite button.
14. ION/INTE EYE button: This button is a composite button. Press SHIFT button switches the function between ION and INTE EYE.

For ION function, when press this button starts or stops the ION function.

For INTE EYE function, when press this button starts or stops the INTE EYE function.
15. SLEEP/CLEAN button: This button is a composite button. Usually it used for SLEEP function, when press SHIFT button, this button used for CLEAN function. The CLEAN function only effective under the remote control is turned off.

Press SLEEP button to set sleep function or cancel sleep function. After setting the sleep function, the sleep function will not be canceled when changing modes. When set the sleep function, the fan speed will switch to low fan speed automatically, but the fan speed can be changed when press the FAN SPEED button. If the turbo function is set, the sleep function will be canceled.

CLEAN button only effective under the remote control is turned off. No signal under other states when press this button. Under the remote control is turned off, press this button to switch on the machine, the remote control enters cooling mode with setting temperature 25°C and high fan speed.
16. LAMP/HOLD button: This button is a composite button. When press SHIFT button switches the function between LAMP and HOLD. For LAMP function, when press this button starts or cancels LAMP function. There is no icon shown on the display screen when start or cancel LAMP function. For HOLD function, when press this button

locks or unlocks the keyboard.

17. RST button: This button is used to reset the microcomputer. When display abnormal or other function abnormal happened, press this button to reset the microcomputer, the remote control backs to the initial state on the electricity.

18. FRESH/FOLLOW ME button: This button is a composite button. When press SHIFT button switches the function between FRESH and FOLLOW ME. There is no icon shown on the display screen when starts or stops FRESH function.

19. °C/°F button: This button is used to switch Fahrenheit and Celsius temperature display on the remote control.

Replacement of Batteries

REPLACEMENT OF BATTERIES

- When the signal from the remote controller becomes weak and the indoor unit can not receive it properly; or the indications on the display screen becomes blurred, please slide the back cover and replace with two new batteries.
- The positive and negative poles must match the installation positions.
- New batteries of the same type have to be used for replacement.
- If the remote controller is not to be used for long time, take out the batteries so as to prevent the leakage of the electrolyte from damaging the controller.
- If when the remote controller is at abnormal state, you can take out the batteries on the back cover to clear off the display.



Basic principles and performances

Features of Heating Operations

- The machines absorb heat from the outdoor air and transfer it indoors so as to heat the room air. The heating capabilities through this principle of heat pump go up/down with the increase/decrease of the temperatures of the outdoor air.
- It only needs a fairly short time for such hot air circulation system to raise the room temperature.
- When the outdoor air temperature is very low, the system can be used together with other heating devices. But good ventilation should be maintained to ensure safety and prevent accidents.

Defrosting

When the outdoor air temperature is very low and humidity is very high, frosting will occur to the heat exchanger of the outdoor unit, which has negative impacts upon the efficiency of the heating performance. In such case, the automatic defrosting function will come into play. The heating operation will be stopped for 5-10 minutes to do the defrosting.

- The fans of both the outdoor and indoor units are stopped.
- During the defrosting, the outdoor unit might generate some steam. It is caused by fast defrosting, which is not a performance failure.
- Upon the completion of the defrosting process, the heating operation is resumed.

To be in compliance EN61000-3-11, the product shall be connected only to a supply of the system impedance: $|Z_{sys}| \leq 0.22008$ ohms or less. Before connect the product to public power network, please consult your Local power supply authority to ensure the power network meet above requirement.

Methods of maintenance

USER'S MANUAL Split Wall-Mounted Air Conditioner

【Methods of maintenance】

The air conditioner must be turned off and plug pulled out before the maintenance is to be carried out.

Before the season of operation

- 1 Check if there are any blocking materials in the intake and outlet vents of the indoor and outdoor units.



- 2 Check if the installation stand is corroded or rusty.

- 3 Check if the machine is properly grounded.

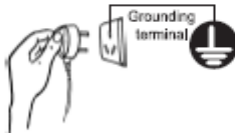

- 4 Check if the air filter is clean.

- 5 Connect to the power source.

- 6 Put batteries in the remote controller.

During the season of operation

The cleaning of the air filter screen (Standard intervals should be once every two weeks).

- 1 Remove the air filter screen from the unit.

- Gently press the two lower ends of the grid and open it.
- Gently pull up the air filter screen and take it out in the direction of your body.

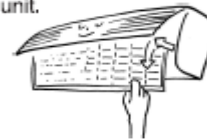

- 2 Clean the air filter screen.

if the screen is very dirty, please use lukewarm water (about 30°C or 86°F) to clean it. Air it dry after the cleaning.

Notes:

- Do not use boiling water to clean the screen.
- Do not bake the screen dry over a fire.
- Do not exert too much force in pulling and stretching the screen.

- 3 Install the air filter screen.

To operate the air conditioner without the air filter screen on will cause the interior of the machine dirty which might lead to poor performances or damages to the units.

Clean the air conditioner

- Use a soft and dry cloth to rub the air conditioner, or use a vacuum cleaner to clean it.
- If the air conditioner is very dirty, use a piece of cloth and soak it with neutral home-use detergent to do the cleaning.



After the season of operation

- 1 Set the temperature at 30°C or 86°F and operate in the fan status for about half a day.



To make the interior of the units dry

- 2 Stop the operation of the machine and turn off the power switch.

The air conditioner will consume about 5W of electric power after the machine is turned off. For the purpose of energy saving and safety, it is advisable to pull the plug out during the non-operational seasons.



- 3 Clean and install the air filter screen.

- 4 Clean the indoor and outdoor units.



- 5 Take the batteries out from the remote controller.



Note:

If the air filter screen is blocked by dust or dirt, the performance of cooling and heating will be affected, with the operation noise and power consumption increased. Therefore, the air filter screen should be cleaned regularly.



【Treatment at service call】

Please check the following before requesting after-sale service from your dealer .



The air conditioner does not operate at all .

<p>Is the power plug in an outlet ?</p> 	<p>Is the time set to "ON" position ?</p> 	<p>Is there a power failure or a blown fuse ?</p> 
---	---	---

Poor cooling or heating performance ,







<p>Is the room temperature setting suitable ?</p> <p>suitable TEMP</p> 	<p>Are the air filters clean (Not clogged) ?</p> 	<p>Are the window (s) and door (s) opened ?</p> 
--	--	---

Poor cooling performance .

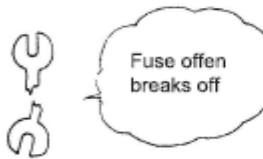

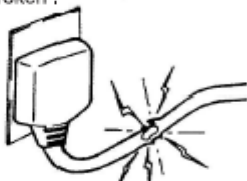
<p>Is direct sunlight entering the room ?</p> 	<p>Is there a heat source in the room ?</p> 	<p>Are there too many people in the room ?</p> 
---	---	--

Cases requiring immediate contact with the distributor

Pull out the power plug immediately and inform to your distributor in the following situations:

<p>Fuse or breaker often breaks off</p> 	<p>Power plug or cord is excessively hot</p> 	<p>Covering of power plug or cord is broken .</p> 
<p>Malfunction is observed TV , radio or other devices .</p> 	<p>Switch dose not actuate surely</p> 	<p>Abnormal noise is heard during operation</p> 
<p>When faulty operation movement is observed when the RUN button is pressed , even after pulling out the power plug and restarting the operation after 3 minutes , faulty movement does not disappear .</p> 		

[We hope you will know the following when using the unit]

<p>The unit can not be restarted just after shut down . (RUN lamp is illuminating)</p> 	<p>Restart is stopped for 3 minutes after shut down to protect the unit .</p>  <p>Three-minute protection timer incorporated in the microcomputer actuates automatically . Except that power is connected , this function does not actuate .</p>
<p>Air is not blown out at starting of heating operation ,</p>	<p>Air blow is stopped to prevent blowing out of cold air until the indoor heat exchanger is warmed .(2 to 5 min) (HOT KEEP)</p>
<p>The unit will not stop blowing out the air immediately after shut down at COOL operation(some model).</p>	<p>Because the unit is doing mould proofing operation and indoor fan motor runs at low speed .The louver will not close down until after 30 seconds.</p>
<p>Air is not blown out for 6 to 12 min , at heating operation .</p>	<p>When outdoor temperature is low and humidity is high , the unit sometimes performs defrosting automatically . Please wait , During defrosting , water or steam are raising from the outdoor unit .</p>
<p>Air is not blown out at DRY operation .</p>	<p>Indoor fan is sometimes stopped to prevent vapor of dehumidified moisture and save energy .</p>
<p>Mist is blown out at COOL operation .</p>	<p>This phenomenon sometimes occurs when the temperature and humidity of the room are very high , but it will disappear with the lowering of the temperature and humidity .</p>
<p>Odor is sent out .</p>	<p>Air blown out during operation may smell . This is the smell of tobacco or cosmetics sticked to the unit .</p>
<p>Noise is heard cracking sound .</p> 	<p>This is caused by the refrigerant that is circulating inside the unit.</p>

<p>Noise is heard cracking sound .After a power stoppage or after disconnecting the power supply plug.</p>	<p>This is caused by heat expansion or contraction of plastics.</p>
<p>Operation can not be restarted even if the power is recovered.</p>	<p>The memory circuit of the microcomputer is cleared, Operate the remote controller again to restart the operation .</p>
<p>Remote control signals are not received .</p>	<p>Remote control signals may not be received when signal receiver on the air conditioner body is exposed to direct sunlight or strong lighting . In that case , interrupt the sunlight or darken the lighting.</p> 
<p>Moisture may form on the air outlet grilles .</p>	<p>If the unit is operated for a long period of time with the high humidity , moisture may form on the air outlet grilles and drip down .</p>